



Installation - Operation Manual

BACTRON300, BACTRON300-2

110 – 120 Volts

220 – 240 Volts



**BACTRON300 Front and
Left Side View**



**Back and Right Side View
of new Access Door**



Warning: This product contains chemicals, including Triglycidyl Isocyanurate, known to the State of California to cause cancer as well as birth defects or other reproductive harm. For more information, go to www.P65Warnings.ca.gov.

iAdvertencia! Este producto contiene sustancias químicas, incluido el triglicidil isocianurato, que el estado de California sabe que causa cáncer, así como defectos de nacimiento u otros daños reproductivos. Para obtener más información, visite www.P65Warnings.ca.gov.

Avertissement! Ce produit peut vous exposer à des produits chimiques, dont l'isocyanurate de triglycidyle, reconnu par l'État de Californie pour provoquer le cancer, des anomalies congénitales ou d'autres problèmes de reproduction. Pour plus d'informations, visitez le site www.P65Warnings.ca.gov,

BACTRON300 Anaerobic Chamber

110 – 120 Volts

220 – 240 Volts

Part Number (Manual): 4861866

Revision: Aug 15, 2024

Sheldon Part ID Numbers:

Model	BACTRON300	BACTRON300-2
Part ID	BAA30023	BAA30023-2

The Part ID denotes the specific build type of the model.



Bactron is a brand of Sheldon Manufacturing, INC, an ISO 9001 certified manufacturer.

Safety Certifications

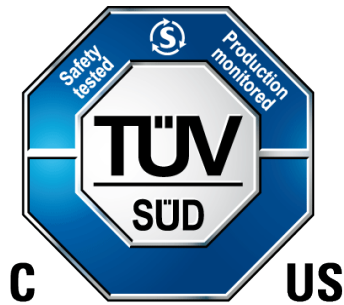

EN 61010-1:2010/A1:2019

EN IEC 61010-2-010:2020

UL 61010-1:2012/R:2023-06

UL 61010-2-010:2019

CSA C22.2 No. 61010-1:2012/U3:2023-06

CSA C22.2 No. 61010-2-010:2019

TABLE OF CONTENTS

Introduction	7
<i>Read this Manual.....</i>	7
<i>Safety Considerations and Requirements</i>	7
<i>Contact Assistance</i>	9
<i>Engineering Improvements</i>	9
<i>Manufacturing Defect Warranty.....</i>	9
<i>Required Items</i>	10
<i>Reference Sensor Device</i>	13
RECEIVING YOUR BACTRON300.....	15
<i>Inspect the Shipment</i>	15
<i>Orientation.....</i>	17
<i>Record Data Plate Information</i>	19
INSTALLATION	21
<i>Installation Checklist.....</i>	21
<i>Required Ambient Conditions</i>	22
<i>Sufficient Workspace</i>	22
<i>Environmental Disruption Sources</i>	22
<i>Eliminate UV Lighting.....</i>	23
<i>Power Requirements.....</i>	23
<i>Gas Supply Requirements</i>	24
<i>Lifting and Handling</i>	26
<i>Leveling.....</i>	26
<i>Installing the BACTRON300.....</i>	26
<i>Attach the Regulator to the Gas Supply Cylinder.....</i>	27
<i>Connect to the Gas Supply.....</i>	27
<i>Connect the Foot Pedal Switch</i>	28
<i>Fill the Manometer</i>	28
<i>Vacuum Supply</i>	29
<i>Installation Cleaning and Disinfection</i>	29
<i>Place Anaerobic Monitoring Strips.....</i>	30
<i>Install Incubator Shelf Spacers.....</i>	30
<i>Open the Incubator Doors</i>	30
<i>Close the Airlock Doors.....</i>	31
<i>Installing the Armport Doors.....</i>	31
GRAPHIC SYMBOLS.....	33
CONTROL PANEL OVERVIEW	35
<i>Main Panel Incubator Controls.....</i>	35
<i>Shadowbox Control Panel</i>	38
<i>BACTRON300 WORKSPACE INCUBATOR.....</i>	39
OPERATION	41
<i>Theory of Operation</i>	41
<i>Put the BACTRON300 into Operation</i>	44
<i>Install an O₂ Scrubber Cartridge</i>	47
<i>Plug In the BACTRON300.....</i>	47
<i>Supply Gas to the BACTRON300.....</i>	48
<i>Zero the Pressure Displays.....</i>	49
<i>Launch the Anaerobic Commissioning Cycle</i>	50
<i>Attach the Sleeves</i>	51
<i>Enter the Chamber</i>	52
<i>Moving in the Pressurized Chamber</i>	54
<i>Vacuuming Down Ballooning Sleeves.....</i>	55

<i>Anaerobic Monitoring Strips</i>	55
<i>Verify the Anaerobic Atmosphere</i>	56
<i>Exit the Chamber</i>	57
<i>Set the Incubator Temperature Setpoint</i>	58
<i>Set the Over Temperature Limit</i>	59
<i>Set the Airlock Cycle Iterations</i>	60
<i>Cycling the Airlock</i>	60
<i>Manually Cycling the Airlock</i>	61
<i>Airlock Safety Aborts</i>	62
<i>Vacuum Pump Cooldown Lockout</i>	62
<i>Inner Airlock Door Lock</i>	62
<i>Loading Samples</i>	63
<i>Humidifying the Incubators</i>	64
<i>Chamber Accessory Power Outlets</i>	64
<i>Volatile Compound Scrubber and Rejuvenation Cycle</i>	64
<i>Condensation and the Dew Point</i>	65
<i>Deionized and Distilled Water</i>	66
<i>Pressure Unit Conversion Chart</i>	66
USER MAINTENANCE	67
<i>Daily Maintenance</i>	68
<i>Normal Gas Consumption</i>	68
<i>Troubleshooting Persistent Oxygen in the Chamber</i>	69
<i>Leak Diagnostic – Unit in Use Procedure</i>	70
<i>Leak Check – Unit Empty</i>	72
<i>Door Gasket Maintenance and Usage</i>	73
<i>Sleeve Maintenance and Usage</i>	73
<i>O₂ Scrubber Cartridge: Test in the Chamber</i>	74
<i>Reactivating O₂ Scrubber Cartridges</i>	74
<i>Quality Control Test – Scrubber Cartridges</i>	75
<i>AMG Conservation Methods</i>	75
<i>Replacing Sleeve Components</i>	76
<i>Cleaning and Disinfecting</i>	77
<i>Maintaining the Acrylic Glass Panels</i>	79
<i>Electrical Components</i>	79
<i>Calibrate the Temperature Display</i>	80
UNIT SPECIFICATIONS	85
<i>Power</i>	85
<i>Unit Weight</i>	85
<i>Shipping Weight</i>	85
<i>Unit Dimensions</i>	85
<i>Shelf Dimensions</i>	86
<i>Airlock Dimensions</i>	86
<i>Incubator Dimensions</i>	86
<i>Volumes and Capacity</i>	86
<i>Temperature</i>	87
<i>Power</i>	87
<i>Oxygen</i>	87
PARTS LIST	88
<i>Ordering Parts and Consumables</i>	90
ACCESSORIES	91
APPENDICES	95
<i>AMG Usage</i>	95
<i>PLC Inputs and Outputs</i>	96

This page left blank.

INTRODUCTION

Thank you for purchasing a BACTRON300 Anaerobic Chamber. We know you have many choices in today's competitive marketplace when it comes to anaerobic cultivation systems. We appreciate you choosing ours. We stand behind our products and will be here for you if you need us.

READ THIS MANUAL

Failure to follow the guidelines and instructions in this user manual may create a protection impairment by disabling or interfering with the unit safety features. This can result in injury or death.

Before using the unit, read the manual in its entirety to understand how to install, operate, and maintain the unit in a safe manner. Ensure all operators are given appropriate training before the unit begins service.

Keep this manual available for use by all operators.

SAFETY CONSIDERATIONS AND REQUIREMENTS

Follow basic safety precautions, including all national laws, regulations, and local ordinances in your area regarding the use of this unit. If you have any questions about local requirements, please contact the appropriate agencies.

SOPs

Because of the range of potential applications this unit can be used for, the operator or their supervisors **must** draw up a site-specific standard operating procedure (SOP) covering each application and associated safety guidelines. This SOP **must** be written and available to all operators in a language they understand.

Intended Applications and Locations

BACTRON300 Anaerobic chambers are intended for professional, industrial, and educational applications suitable for the cultivation of clinical bacteria. These units are not intended for use at hazardous or household locations. Use this equipment only for its intended range of applications.

Power

Your unit and its recommended accessories are designed and tested to meet strict safety requirements.

- The unit is designed to connect to a power source using the specific power cord type shipped with the unit.
- Always plug the unit's power cord into a protective earth-grounded electrical outlet conforming to national and local electrical codes. If the unit is not grounded properly, parts such as knobs and controls can conduct electricity and cause serious injury.
- Do not bend the power cord excessively, step on it, or place heavy objects on it.
- **A damaged cord can be a shock or fire hazard. Never use a power cord if it is damaged or altered in any way.**
- Use only approved accessories. Do not modify system components. Any alterations or modifications to your unit not explicitly authorized by the manufacturer can be dangerous and will void your warranty.



BACTRON300

CONTACT ASSISTANCE

Phone hours for Support are 6 am – 4:30 pm Pacific Coast Time (west coast of the United States, UTC-8), Monday – Friday.

Please have the following information ready when calling or emailing Technical Support: the **model number** and the **serial number**. These will be found on the unit data plate located in the workspace chamber above the inner airlock door. See page 19.

support@sheldonmfg.com
800-322-4897 extension 4
503-640-3000 extension 4

Sheldon Manufacturing, INC.
P.O. Box 627
Cornelius, OR 97113
USA

ENGINEERING IMPROVEMENTS

Sheldon Manufacturing continually improves its products. As a result, engineering changes and improvements are made from time to time. Therefore, some changes, modifications, and improvements may not be covered in this manual. If your unit's operating characteristics or appearance differ from those described in this manual, please contact your BACTRON300 dealer or distributor for assistance.

MANUFACTURING DEFECT WARRANTY

For information on your warranty and online warranty registration please visit:

- sheldonmanufacturing.com/warranty

REQUIRED ITEMS

The following consumables and equipment are required for the operation of the BACTRON300 and **must be purchased separately** from the unit.

AMG Supply

The BACTRON300 requires a continual supply of Anaerobic Mixed Gas to establish and maintain an anaerobic atmosphere. The gas mix must have 5% hydrogen to drive the BACTRON300 catalytic oxygen scrubbing process. The manufacturer recommends an AMG mixture ratio of **5% hydrogen, 5% carbon dioxide, and 90% nitrogen**.

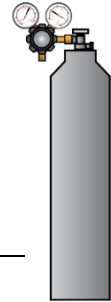

Note: Do Not exceed 5% hydrogen concentration or explosive mixtures can occur.

The BACTRON300 can be connected to either a standalone supply cylinder or an in-house system. Please see page 24 for more information.

On-Site Supply

The manufacturer strongly recommends keeping at least two size 200 cylinders of AMG (size N 8.76M³) on hand or a house supply system equivalency to ensure a continual supply of AMG.

Anticipated Gas Usage

AMG usage in the BACTRON300 is highly variable. Consumption is primarily driven by the following factors:

- The number of times the chamber is accessed each day.
 - Airlock and armport sleeve cycles consume AMG.
- The amount of time laboratory personnel spent working with their arms in the sealed workspace chamber.
 - Movement displaces the chamber atmosphere, some of which is vented and must be replaced with AMG injections.
- Laboratory personnel should adhere as close as possible to the proper movement technique guidelines while working in the chamber.

Page 95 contains AMG usage data for specific BACTRON300 operations.

Airlock cycles may be supplemented with nitrogen to help reduce AMG use. Please see pages 24 and 25 for additional gas requirement information.

Required Gas Pressure Delivery to the BACTRON300

Delivery of less than 50 psi gas flow pressure to the BACTRON300 may slow cycle times. Delivery pressures of less than 40 psi will interrupt the airlock, sleeve, and commissioning cycles, and prevent the BACTRON300 from keeping overpressure in the workspace chamber.

Factors that can reduce gas pressure delivery include:

- The total volume of the delivery system, including:
 - The distance between the BACTRON300 and the supply source.
 - Incorrectly sized gas tubing.
- The total number of units attached and drawing from a building gas supply system.
- Incorrect regulator settings.

Gas regulators may be set higher than 50 psi gas flow to overcome factors lowering the pressure in the supply system, if necessary. **Never exceed a setting of 60 psi.**

Note: The **Gas Regulator is not included** with this unit. It can be purchased separately from Sheldon Manufacturing or any other manufacturer of your choice.

The manufacturer recommends waiting to introduce electronic devices into the workspace chamber until an anaerobic atmosphere has been established. Condensation may take place in the chamber during the anaerobic commissioning cycle.

Open and Center the incubator doors.

The incubator doors must be open and centered during the commissioning cycle while the BACTRON300 establishes an anaerobic atmosphere in its workspace chamber.

- Failure to open the incubator doors will leave significant reservoirs of oxygenated atmosphere in the incubators.
- The airlock doors **must** be closed and latched prior to launching a commissioning cycle. The inner door will lock when the BACTRON300 is turned on.
- The armport doors must be installed for the commissioning cycle to successfully create an anaerobic atmosphere.

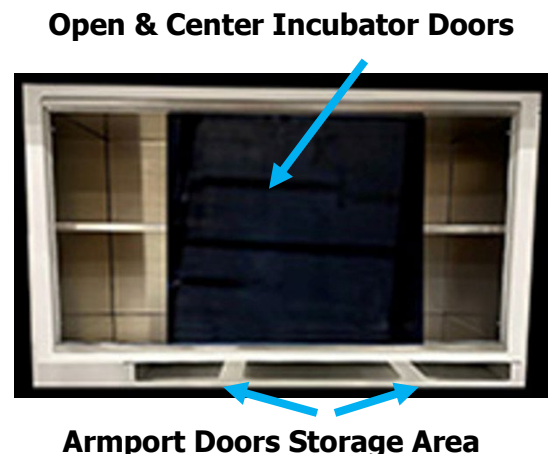

Scrubber Cartridge Oven



The BACTRON300 requires a scrubber cartridge oven to reactivate the O₂/activated carbon media scrubber cartridges.

Each cartridge requires a bake out of at least 8 hours at 200°C to reactivate after 24-hours of use in the chamber. This necessitates at least one bake-out per day, with one scrubber mounted in the BACTRON300 workspace chamber while the other is being baked out.

Glassware



A glassware beaker or flask is placed under the drain tube for the condensate-capturing chiller plate in the chamber.

The manometer pressure valve/gauge in the workspace chamber requires periodic water refills. Water is added by pouring or injecting water into the fill port on the top of the manometer body. Using a beaker or other glassware for transporting and pouring water into the manometer.

Two 500 ml beakers or a container fan will be needed if you intend to use activated carbon media to scrub volatile fatty and sulfur compounds out of the workspace chamber atmosphere.

Oxygen Detection Strips



The BACTRON300 uses a minimum of 1 Oxoid brand oxygen-detecting anaerobic indicator strip every 24 hours to provide continual anaerobic surveillance in the workspace chamber. Part Number 9900706, 1 box of 100 strips.

Each BACTRON300 comes with five oxygen detection strips. Five strips are sufficient to verify that an anaerobic atmosphere has been established in the workspace chamber.

REFERENCE SENSOR DEVICE

Must be purchased separately.

A reference sensor device is required for calibrating BACTRON300 incubator temperature displays.

Reference devices must meet the following standards:

- Accurate to at least 0.1°C

The device should be regularly calibrated, preferably by a third party.

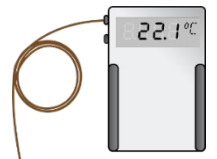

Temperature Reference

Temperature Probe

Use a digital device with a wire thermocouple probe that can be introduced into the incubator through the incubator door space. Select thermocouples suitable for the application temperature at which you will be calibrating.

Why Probes?

Reference readings taken outside an incubator using a wire temperature probe avoids incubation chamber door openings. Openings disrupt the chamber temperature. Each disruption requires a **minimum 1-hour wait** to allow the temperature to re-stabilize before continuing. **Always use thermocouple probes.**

No Alcohol or Mercury Thermometers

Alcohol thermometers do not have sufficient accuracy to conduct accurate temperature calibrations. **Never place a mercury thermometer in an incubator!**

This page left blank.

RECEIVING YOUR BACTRON300

INSPECT THE SHIPMENT

1. When a unit leaves the factory, its **safe delivery becomes the responsibility of the carrier.**
2. Damage sustained during transit is not covered by the manufacturing defect warranty.
3. Save the shipping carton until you are certain the unit and its accessories function properly.

When you receive your unit, inspect it for concealed loss or damage to its interior and exterior. If you find any damage to the unit, **follow the carrier's procedure for claiming damage or loss.**

1. Carefully inspect the shipping carton and report any damage to the carrier service that delivered the unit.
2. If the carton is not damaged, open the carton and remove the contents.
3. The unit should come with an end-user Installation and Operation.
4. Verify that the correct number of accessory items have been included.

See next page for required & useful accessories items.

Standard accessory items included with the BACTRON300 and BACTRON300-2:

Anaerobic Monitoring Strips (5 packets)



Do not open now!

Armport Door Left



Armport Door Right



Shelf Spacers (3)



O₂ Scrubber Cartridges (2)



Leave in the package! Do not unwrap now.

Foot Switch Control



Power Cords NEMA 5-15P (2)



Leveling Feet (4)



Medium Sleeve Assemblies (2) (Size 8)



Small Sleeve Cuffs (2) (Size 7)



Armport Door Stands (2)



Vacuum Supply: The BACTRON300 comes with an internal vacuum pump.

RECEIVING YOUR BACTRON300

Required and Useful Accessories

1. An AMG regulator and a second O₂ scrubber are required to operate the BACTRON300.

NOTE: The AMG Regulator is not included with the BACTRON300 and must be purchased separately, either from Sheldon Manufacturing or any other vendor of your choosing.

2. The unit comes with an LED Light Unit 220V and 2 X 11 Petri Dish Racks; these components can be ordered separately.

O₂ Scrubber Cartridge



9990759
Required!

LED Light Unit 220V

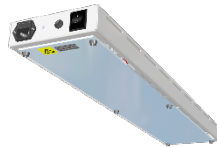

9730520

Petri Dish Rack
(2 X 11 Plates)



5110729

ORIENTATION

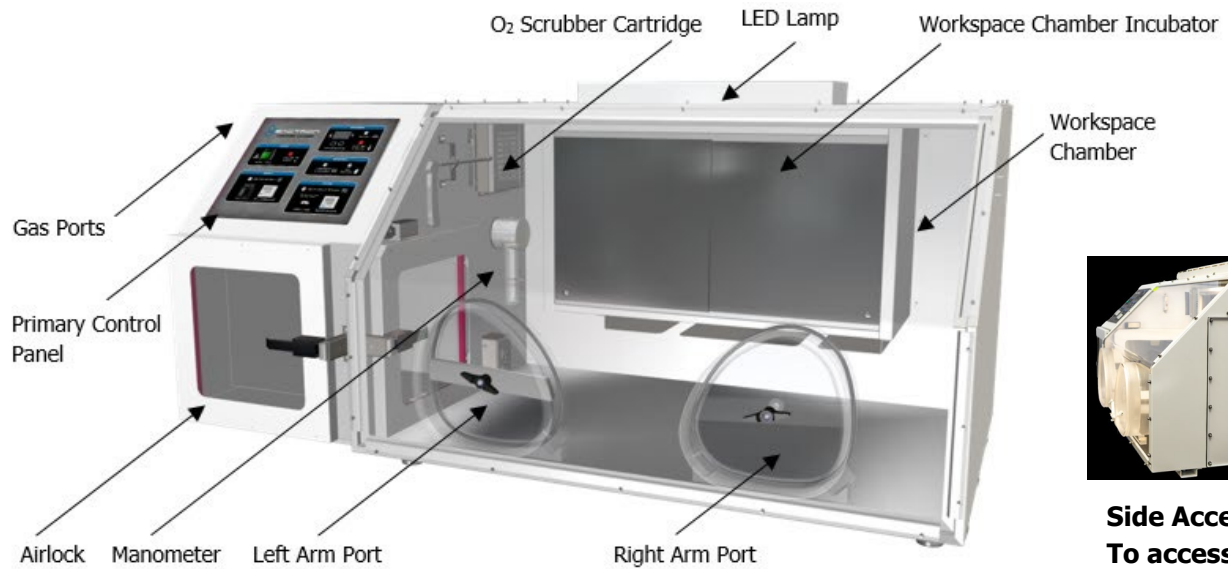

**Side Access Panel –
To access the
chamber, remove all
the screws.**

Figure 1: BACTRON300 / BACTRON300-2

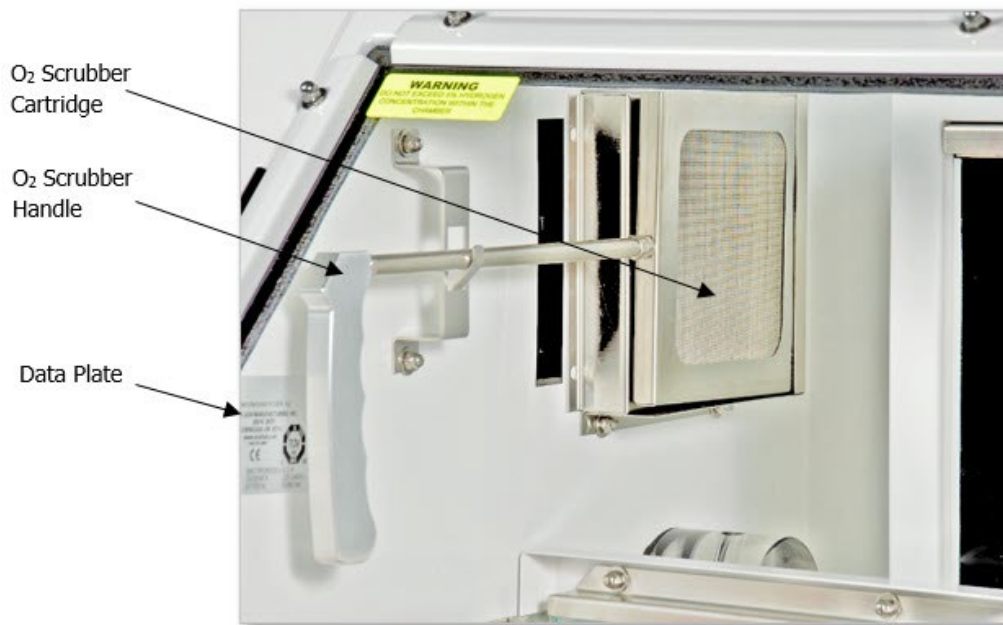

Figure 2: Workspace Chamber Layout

RECEIVING YOUR BACTRON 300

Workspace Chamber Orientation

BACTRON300

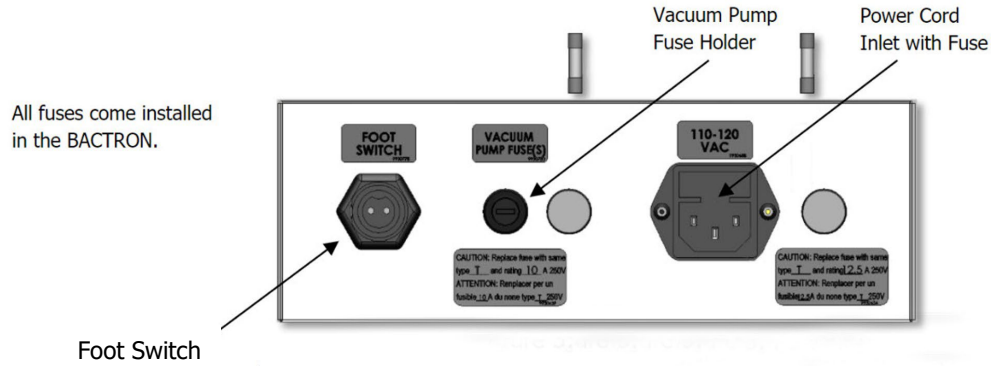

Figure 3: Power Supply Panel
(Located on back of unit, behind the Airlock)

Airlock Orientation



Figure 4: Airlock Inner Door and Sliding Shelf

The airlock has a sliding shelf, and the shelf can transport up to 216 plates at a time.

RECORD DATA PLATE INFORMATION

The data plate contains the incubator **model number, serial number, part number,** and **Part ID number.** Tech Support will need this information during any support call. Record it below for future reference.

- The data plate is located in the workspace chamber above the inner airlock door.

Data Plate Information

Model No:	
Serial No:	
Part No:	
Part ID:	

This page left blank.

INSTALLATION

INSTALLATION CHECKLIST

Pre-Installation:

- ✓ Check that sufficient countertop space is available for the BACTRON300. Rolling stands to mount the BACTRON300 are available for purchase. Please see pages 22 and 91.
- ✓ Check that the ambient conditions and ventilation spacing requirements are met, page 22.
- ✓ Check for sources of temperature and atmospheric disruption in the environment, page 22.
- ✓ Verify that no damaging UV light sources are present, page 23.
- ✓ Check that a suitable electrical outlet is present, page 23.
- ✓ Procure an AMG gas supply for the BACTRON300 suitable for your application. See page 24 for gas requirements.

Optional: Obtain a nitrogen (N₂) supply to reduce AMG usage during airlock cycles. Obtain an N₂ regulator and tubing. Please see pages 24 and 93.

Install the BACTRON300 in a suitable location:

- ✓ Review lifting and handling instructions, page 25.
- ✓ Make sure the BACTRON300 is level, page 26.

Set up the BACTRON300 for use:

- ✓ Connect the gas supply source(s) to the BACTRON300, page 27.
- ✓ Connect the foot pedal switch to the BACTRON300, page 28.
- ✓ Fill the manometer in the workspace chamber with water, page 28.
- ✓ Clean and disinfect the BACTRON300, accessories, and items that will be placed in the chamber, page 29.
- ✓ Place the listed BACTRON300 accessories in the chamber, page 29.
- ✓ Place 5 unopened anaerobic monitoring packets or strips in the workspace chamber, page 30.
- ✓ Install shelf spacers in the workspace incubator (BACTRON300), page 30.
- ✓ Open the incubator doors open (centered), page 30.
- ✓ Close and latch both airlock doors, page 31.
- ✓ Install the armport doors, page 31.

INSTALLATION

REQUIRED AMBIENT CONDITIONS

BACTRON300s are intended for use indoors at ambient room temperatures between **+15°C to 30°C (59°F and 86°F)**, at no greater than **80% Relative Humidity** (at 25°C / 77°F). The room temperature should not vary more than $\pm 1^\circ\text{C}$ per hour.

Operating the BACTRON300 outside of these conditions may adversely affect its incubator temperature stability and effective operating range. For conditions outside of those listed above, please contact your BACTRON300 distributor to explore other options suited to your laboratory or production environment.

SUFFICIENT WORKSPACE

2.5 inches (64mm) minimum clearances required for unobstructed airflow and cooling:

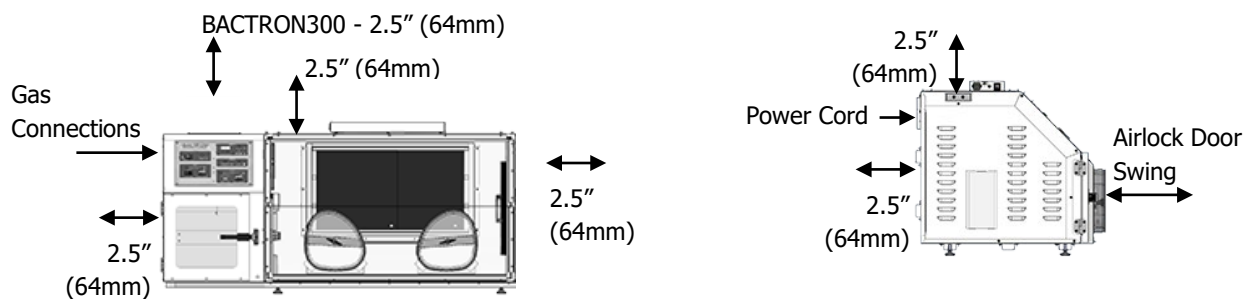

- **Gas Connections:** The BACTRON300 requires a continual connection to 1 or 2 compressed gas sources. Ensure there is sufficient space to access these connections.
- A control panel is located in the shadow box on the left side of the unit, behind a sliding door. Ensure users have sufficient room to access the panel.
- Please see page 85 for unit dimensions. Caster-mounted stands for BACTRON300s are available for purchase.

ENVIRONMENTAL DISRUPTION SOURCES

Consider proximate environmental factors that can affect the chamber temperature and atmospheric integrity when selecting a location to install the BACTRON300:

- Ovens, autoclaves, and any device that produces significant radiant heat.
- High-traffic areas
- Direct sunlight
- Heating and cooling ducts, or other sources of fast-moving air currents

Direct exposure to air-conditioning vents or other sources of cold air can result in **condensation or fogging** on the acrylic glass panels of the chamber, depending on humidity and other ambient conditions. Prolonged exposure to cold air flows may adversely affect the incubator temperature performance.

INSTALLATION

ELIMINATE UV LIGHTING

Sustained exposure to direct sunlight, UVC, or UV germicidal lighting around 254nm will cause **rapid aging of the BACTRON300 acrylic glass panels and armport sleeves**. Check to see if your laboratory or workspace contains sources of UV lighting.

Periodic use of long-wave (365nm) UV hand lamps for bacterial identification should not damage the acrylic glass. See the [Maintaining the Acrylic Glass Panels](#) entry on page 79 for more details.

POWER REQUIREMENTS

When selecting a location for the BACTRON300, check that each of the following requirements is satisfied.

Power Source: The power source for the BACTRON300 or BACTRON300-2 must match the voltage and match or exceed the ampere requirements listed on the unit data plate. BACTRON300s are intended for **110 - 120V and 220 – 240V, 50/60 Hz** applications at the following amperages:

Model	Voltage	Amperage
BACTRON300	110-120	11 Amps
BACTRON300-2	220-240	8 Amps

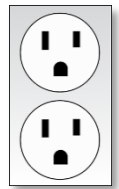

Standard NEMA 5-15P wall socket

- **The unit may be damaged if the supplied voltage varies by more than 10% from the data plate rating.**
- The wall power source must be protective earth-grounded.
- Use a separate circuit to prevent loss of the unit due to overloading or circuit failure.
- **The recommended wall circuit breakers for these units are 15 amps.**
- The wall power source must conform to all national and local electrical codes.

Power Cord and Fuses: The unit must be positioned so that all end-users can quickly unplug the BACTRON300 in the event of an emergency.

- The unit comes with **two 15 Amp, 125V, 9 ft. 5 in. (2.86m) NEMA 5-15P power cords**. Always use these cords or identical replacements.
- These units come with **one T12.5 Amp, 250V 5x20mm fuse** located in the power cord inlet. The unit must be fused to operate.
- These units come with **one T16.0 Amp, 250V 5x20mm fuse** located in the secondary inlet that is wired to the interior outlet. The unit must be fused to operate.

Vacuum Pump: These units each come with an internally mounted vacuum pump.

- The BACTRON300 and BACTRON300-2 have one pair of **T10 Amp, 250V 5x20mm fuses** installed in a fuse holder on the power connection panel on the back of the unit. The fuses must be installed and unblown for the pump to operate.

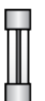

GAS SUPPLY REQUIREMENTS



Warning: Never exceed a 5% hydrogen concentration inside the anaerobic workspace chamber. Exceeding 5% creates an explosion and flammability hazard.

Avertissement: La concentration d'hydrogène ne doit pas dépasser 5% dans la chambre anaérobie. Un dépassement de 5% crée un risque d'explosion et d'inflammabilité.

AMG (Anaerobic Mixed Gas) – Required

A supply source of AMG sufficient to conduct the Anaerobic Commissioning Cycle and operate the unit afterward **must** be on hand prior to placing the BACTRON300 into operation. The Manufacturer strongly recommends keeping a second AMG cylinder on site to ensure a continual supply of AMG.

Anaerobic Mixed Gas is often sold by gas suppliers under the category of *Anaerobic Incubation Mixtures* or *Biological Atmospheres*. Laboratories that are required to be compliant with Good Laboratory Practices may require batch-certified AMG.

Reminder: The recommended BACTRON300 AMG mix is 5% H₂, 5% CO₂, 90% N₂.

Airgas Part Numbers for AMG: H₂ 5%,
CO₂ 5%, N₂ 90%, Size 200, CGA 350:

Z03NI9022000008 – Standard

Z03NI9032000041 – Analyzed with
Certificate.

Contact your site safety officer and review your institutional safety protocols for handling, storing, and using compressed gases. Follow all local ordinances and national regulations regarding compressed gases in research, clinical, or production environments.

AMG Regulator Requirements

Note: An AMG Regulator is required to operate the BACTRON300 but is not included with the BACTRON300 and must be purchased separately.

The AMG Regulator that is available to purchase from Sheldon Manufacturing with the BACTRON300 is compliant with the requirements listed below:

- The regulator for each AMG cylinder must be a **dual-stage regulator** to ensure precise flow rates.
- The AMG regulator **must be rated for hydrogen**.
- **Must** be capable of delivering **50 psi of gas flow** to the BACTRON300 (345kPa).
- The supply tubing from the gas regulator to the BACTRON300 must be **3/16-inch ID** (inside dimension).

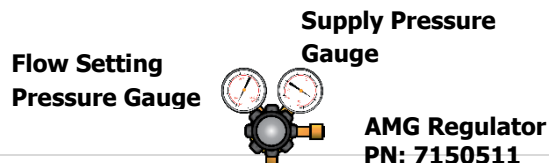

Nitrogen Option - Dual Gas Configuration

AMG is used to cycle the airlock to create and maintain an anaerobic atmosphere in the workspace chamber. This is a major source of AMG usage; however, AMG is only necessary for the final gas backfill. To reduce AMG consumption, connect a nitrogen (N₂) supply to the BACTRON300 **N₂ In** gas port. The BACTRON300 will draw from the **N₂ In** gas port during gas backfills for every iteration of an airlock auto cycle, except the final iteration.

The unit must be connected to both an AMG supply source (**AMG In** port) **and a N₂** source for the dual gas configuration to function. See illustrations on page 27.

- For dual gas configurations, the manufacturer recommends a cylinder of AMG, along with a cylinder of 100% Nitrogen (N₂).
- The nitrogen must be medical or food grade. The use of industrial-grade nitrogen risks introducing impurities into the workspace chamber and damaging components.
- The nitrogen regulator must be a dual-stage regulator rated for nitrogen, connected to 3/16" ID gas tubing, and be capable of delivering 50 psi of gas flow to the BACTRON300 (345kPa).
- The BACTRON300 will not draw from the nitrogen supply during manual airlock cycles or when cycling the armpot sleeves.

Required Gas Pressure Delivery to the BACTRON300

Delivery to the BACTRON300 of less than 50 psi gas flow pressure may slow cycle times. Delivery pressures less than 40 psi will interrupt airlock, sleeve, and commissioning cycles, and prevent the BACTRON300 from maintaining overpressure in the workspace chamber.

Factors that can reduce gas pressure delivery include:

- The total volume of the delivery system, including:
 - The distance between the BACTRON300 and the supply source.
 - Incorrectly sized gas tubing.
- The total number of units attached and drawing from a building gas supply system.
- Incorrect regulator settings.

If necessary, gas regulators may set higher than 50 psi gas flow to overcome factors lowering the pressure in the supply system. **Never exceed a gas flow setting of 60 psi.**

LIFTING AND HANDLING

The BACTRON300 is heavy. Use appropriate powered lifting devices. Follow these guidelines when lifting and handling the BACTRON300:

- Lift the BACTRON300 only from its bottom surface.
 - Doors, handles, and knobs are not adequate for lifting or stabilization.
- Restrain the BACTRON300 completely while lifting or transporting to prevent tipping.
- Remove all removable components, such as shelf spacers and trays, and secure all doors in the closed position during transport and transfer to prevent shifting and damage.

Note: To prevent damage when moving the BACTRON300, turn each of the four leveling feet completely clockwise.

LEVELING

The BACTRON300 must be level and stable for safe operation.

1. Install the leveling feet included with the BACTRON300.

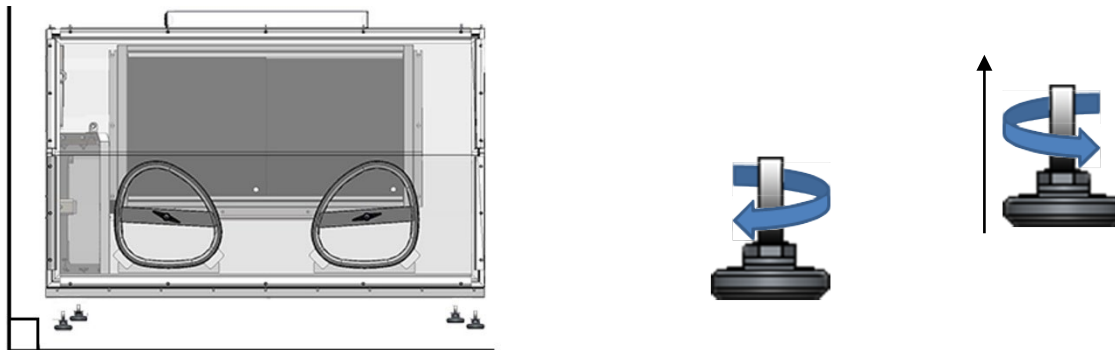

INSTALLING THE BACTRON300

Install the unit in a workspace location that meets the criteria discussed in the previous entries in the Installation section.

Do not connect the unit to its power source at this time.

- Adjust the leveling feet until the chamber stands level and solid without rocking in its workspace location.

INSTALLATION

ATTACH THE REGULATOR TO THE GAS SUPPLY CYLINDER

Note: Skip this procedure if the BACTRON300 will be drawing AMG from a building supply system.

Optional: Attach a nitrogen regulator to a nitrogen supply cylinder now if you will be using the dual-gas configuration.

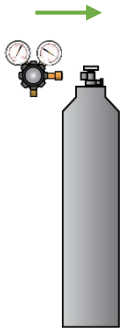

CONNECT TO THE GAS SUPPLY

Warning: Never exceed a 5% hydrogen concentration inside the anaerobic workspace chamber. Exceeding 5% creates an explosion and flammability hazard.

Avertissement: La concentration d'hydrogène ne doit pas dépasser 5% dans la chambre anaérobie. Un dépassement de 5% crée un risque d'explosion et d'inflammabilité.



Single Gas Configuration

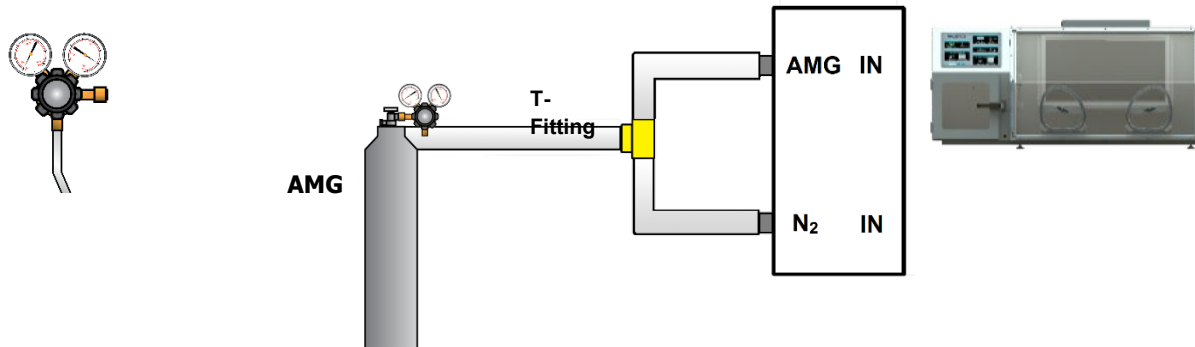

The T-Fitting Adaptor comes with the BACTRON300 Single Gas Configuration

Failure to connect the T-fitting to **both** the AMG and Nitrogen **IN ports** will interfere with the airlock auto cycle. The Nitrogen **IN port** must always be connected to either the AMG or an N₂ supply.

Dual Gas Configuration

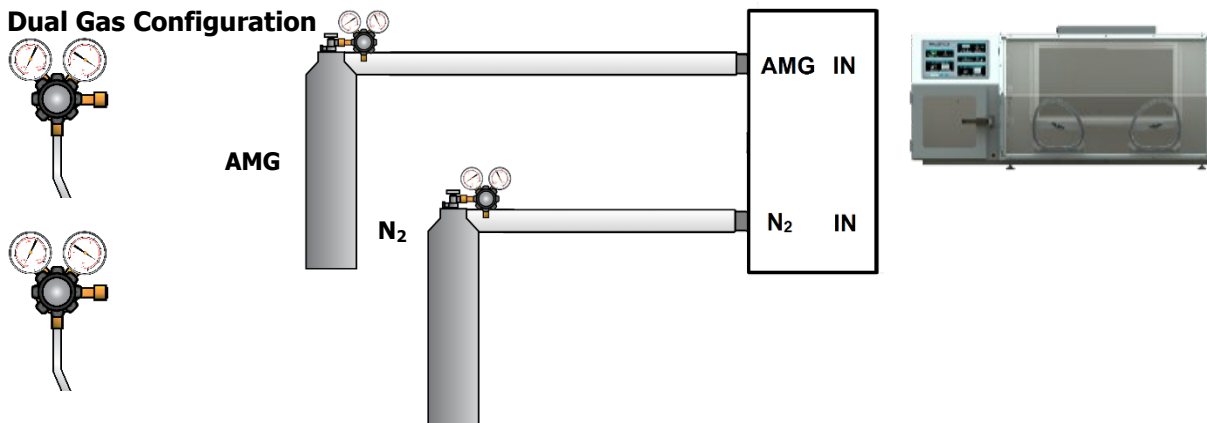

DO NOT start a flow of gas to the BACTRON300 at this time for either configuration.

INSTALLATION

CONNECT THE FOOT PEDAL SWITCH

The foot pedal switch cycles the armports and attached sleeves.

Connect the foot pedal cable to the two-pin female connection on the power access panel on the back of the BACTRON300.

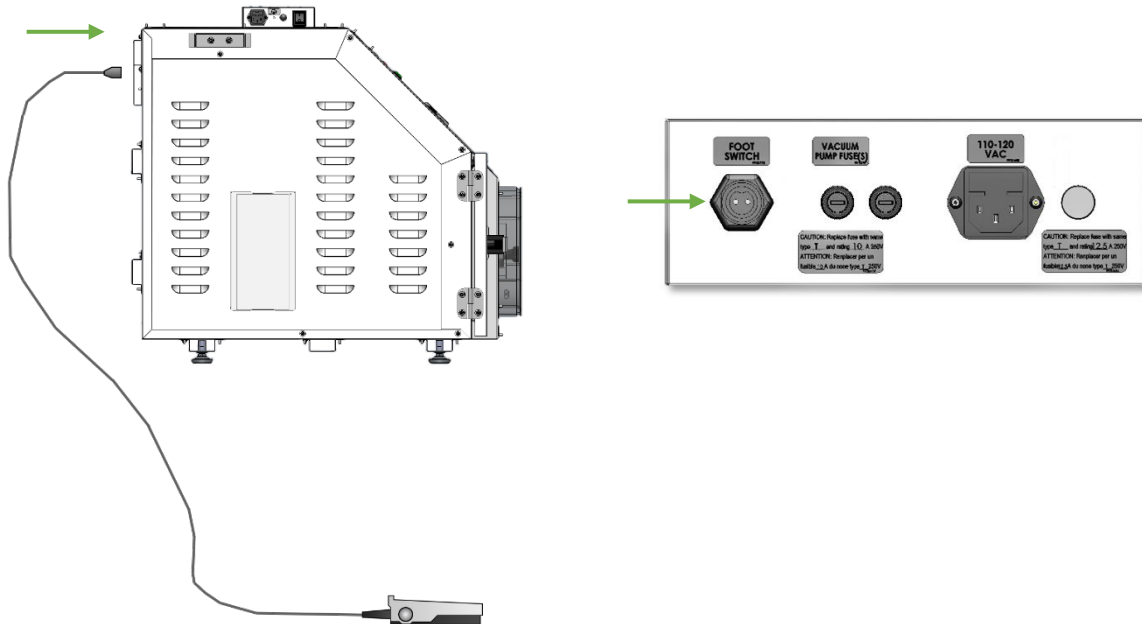

FILL THE MANOMETER

The manometer acts as a pressure relief check valve and as a visual gauge of atmospheric pressure inside the sealed workspace chamber.

The manometer must be filled with 2 fluid ounces (60 ml). Failure to do so will compromise the chamber anaerobic atmosphere.

1. Underfilling or overfilling compromises the manometer accuracy as a pressure gauge and check valve. Fill with 2 fl oz (60 ml) of water.
 - o The water should reach the top (black) measuring ring when the BACTRON300 is Off and the bottom poppet ring when On.
2. To avoid scaling (mineralization build-up), use distilled water. **Never use deionized water.**
3. Fill the manometer via the top fill port.

2 fl oz (60ml)

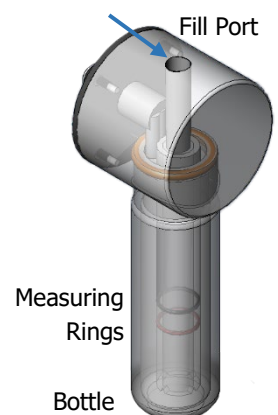
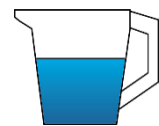

Note: A pipet can aid in reaching the fill port and in avoiding spills.

INSTALLATION

VACUUM SUPPLY

The BACTRON300 comes with an internal vacuum pump which is used to partially evacuate the airlock and the armpot sleeves when cycling to remove oxygen. The BACTRON300 is not designed to connect to an in-house supply system.

INSTALLATION CLEANING AND DISINFECTION

Clean and disinfect the chamber during installation to reduce the chance of microbiological contamination. The BACTRON300 was cleaned and the workspace chamber disinfected at the factory. However, the BACTRON300 may have been exposed to contaminants during shipping, and/or the factory procedure may not meet the standards of your institutional protocols.

Please see the [Cleaning and Disinfecting](#) entry on page 77 in the User Maintenance section for information on how to clean and disinfect the unit without damaging the chamber.

Never use deionized water to clean or rinse the BACTRON300!

1. Remove all protective wrappings from accessories and the unit prior to cleaning/disinfecting.
2. Clean and disinfect the workspace chamber and incubator(s).
3. Clean, disinfect, and place the following accessories in the workspace chamber:
 - The armpot doors
 - The incubator bottom shelf spacers
 - The petri dish rack 2x11
 - The petri dish rack can be placed on the top shelf of the workspace chamber incubator or the BACTRON300 workspace shelves during the setup.
 - A glass flask or beaker. When clean, place the glass flask or beaker under the plastic condensation tube on the left side of the chamber.
 - You may place water-resistant, aerobic-tolerant items into the workspace chamber now. Doing so saves time and AMG usage by eliminating future airlock cycles.



The manufacturer recommends waiting to introduce electronic devices into the workspace chamber until after an anaerobic atmosphere has been established. Condensation may take place in the chamber during the anaerobic commissioning cycle.

Leave the O₂ scrubber cartridge in its packaging and DO NOT place it in the BACTRON300 at this time!



Each O₂ scrubber comes from the factory ready for use. If a scrubber has been stored at your site for longer than 6 months, it will need to be reactivated prior to installation for use. Reactivate the scrubber by baking at 200°C for 8 hours.

INSTALLATION

PLACE ANAEROBIC MONITORING STRIPS

Place at least 5 anaerobic monitoring strip packets in the chamber. Do not place the packets in the incubator.

Do not open the packets at this time! Packets should only be opened in an anaerobic atmosphere. At least one of these strips will be used after establishing an anaerobic atmosphere. Up to a total of five may be required.



INSTALL INCUBATOR SHELF SPACERS

These spacers ensure even heat distribution and uniformity.

1. Set the spacers on the **bottom shelf** of the workspace chamber incubator, side by side, with the "SPACER" label facing outward.

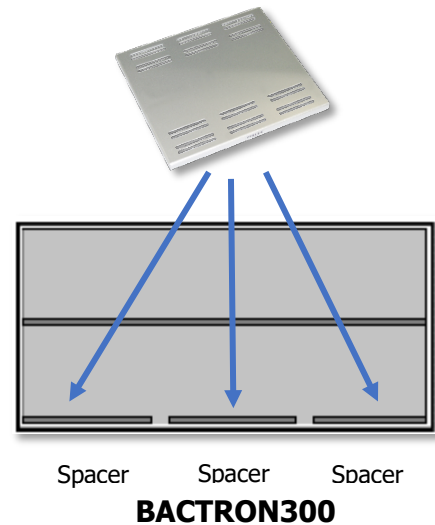

OPEN THE INCUBATOR DOORS

Open both incubator doors by sliding them to the center.

The incubator doors must be open during the commissioning cycle while the BACTRON300 establishes an anaerobic atmosphere in its workspace chamber. Failure to do so will leave significant reservoirs of oxygenated atmosphere in the incubators.



Open and Center Workspace Incubator Doors *(this graphic is for illustrative purposes only)*

INSTALLATION

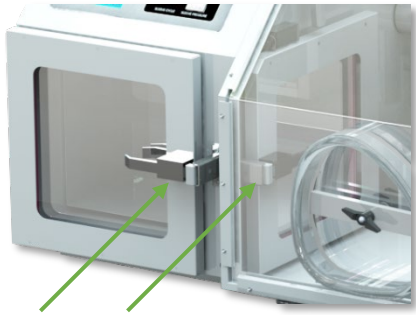

CLOSE THE AIRLOCK DOORS

The airlock doors should be closed and latched prior to launching a commissioning cycle. The inner airlock door will lock when the unit is turned On.



INSTALLING THE ARMPORT DOORS

The armport doors must be installed in order for the commissioning cycle to successfully establish an anaerobic atmosphere.

1. Turn the locking bar on both doors to a roughly 45° position.
2. Insert the tabs for one door into the slots on the bottom of its armports.
3. Pull the top of the door toward you so that it sits balanced and vertical in the armport.
 - Repeat steps 2 and 3 for the second door.
4. Turn the locking bars on both doors to a horizontal position, one at a time.
 - The silver locking bar will move toward the body of the door.
 - Use wrist strength only. Turn until the knob grabs and feels snug. Tightening too much can damage the door.
6. Gently check that the doors sit snug in the ports.
 - The doors should not move when gently pulling on the locking bar or pushing against the door body. User finger strength only.
 - The locking bar should not move.

2

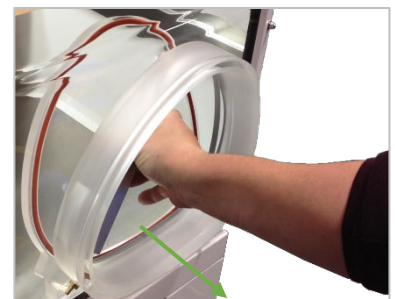

3

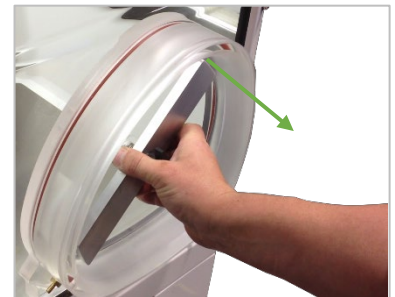

4











5







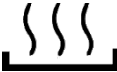

This page left blank.

GRAPHIC SYMBOLS

The BACTRON300 has multiple graphic symbols located on its exterior and interior surfaces. The symbols identify hazards and the functions of the adjustable components, as well as important notes found in the user manual.

Symbol	Definition
	Consult the user manual. Consulter le manuel d'utilisation
	I/ON O/OFF: Controls all power to each chamber and its systems. I indique que l'interrupteur est en position marche. O indique que le commutateur est en position d'arrêt.
	AC Power Repère le courant alternatif
	Low AMG supply alarm Indique l'alarme d'alimentation de gaz basse AMG
	Airlock Anaerobic environment Indique un environnement anaérobie dans le sas
	Temperature display Indique l'affichage de la température
	Incubator heating Indique que l'incubateur chauffe
	Adjusts UP and DOWN Ajuster la température de l'incubateur vers le haut et vers le bas
	Over Temperature Limit Thermostat température limite contrôle haute

Symbol	Definition
	Anaerobic Commissioning cycle in progress Signale un cycle de purge d'oxygène
	Indicates AMG Indique gaz AMG
	Foot pedal control / Sleeve Cycle Indique la commande de la pédale
	Indicates potential shock hazard. Risque de choc électrique
	Recycle the unit. Do not dispose of in a landfill. Recycle l'unité. Ne jetez pas dans une décharge
	Protective earth-ground. Terre électrique
	Manually adjustable. Indique un réglage manuel

CONTROL PANEL OVERVIEW



Figure 5: Main Control Panel

MAIN PANEL INCUBATOR CONTROLS

BACTRON300

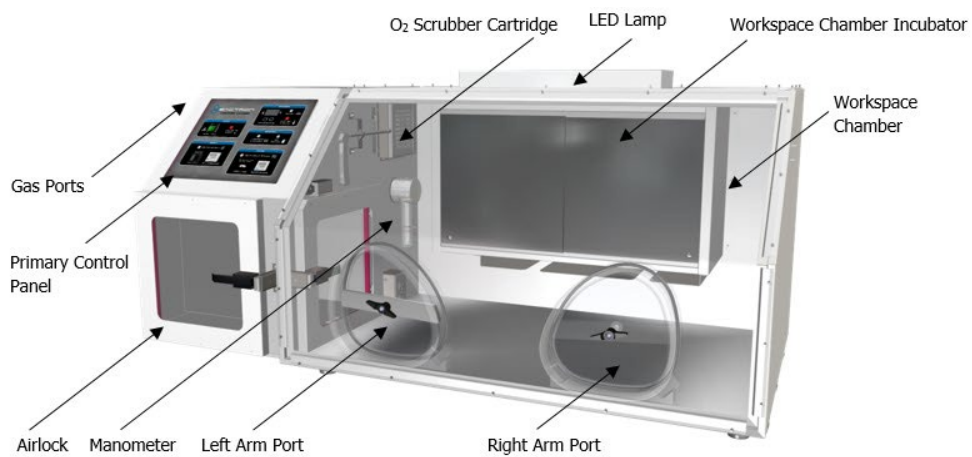

Figure 6: Primary Control Panel operates the workspace chamber incubator.

CONTROL PANEL OVERVIEW

Main Panel Incubator Controls continued

Status

Power Switch



Controls all power to each chamber and its systems.

Low AMG Supply Alarm



If the BACTRON300 detects low pressure in the external AMG supply line lasting longer than 30 seconds, it will illuminate the Low AMG Supply indicator light and sound an alarm beep every 15 seconds. The BACTRON300 will abort any active cycles until pressure is restored in the line.

Airlock

Airlock Anaerobic



This indicator light illuminates during the final gas backfill of an airlock auto cycle. It will remain lit until the next time the outer airlock door is opened, exposing the airlock chamber to aerobic air.

Auto Cycle



Pushing the rocker switch briefly initiates the airlock auto cycle. Pressing and holding the switch for at least 2 seconds aborts the cycle. The number of evacuations – gas-backfill cycle iterations is set using the Airlock Cycle Setting Switch control located on the shadowbox control panel.

Airlock Pressure Display



This display shows the level of atmospheric pressure in the airlock in inches of mercury (inHg). At room pressure, the gauge should read 0. During cycles, the pressure in the airlock drops to -18inHg during evacuations and rises to -4inHg during the gas backfills. The final gas backfill is timed to end with a mild overpressure in the airlock (approximately 0.5inHg) This allows the inner airlock door to be opened without difficulty from inside the overpressure environment of the workspace chamber.

Incubator

Incubator Temperature Display



During normal operations, the display shows the current incubator air temperature, accurate to 0.1°C. The Up and Down buttons are used to change display modes and input either a new temperature setpoint or a calibration adjustment. The display blinks continually while in its setpoint or calibration adjustment modes, preceded by an "SP" for Setpoint or "C O" for Calibration Offset.



The heating indicator light illuminates when the BACTRON300 calls for power to the incubator heating elements.

CONTROL PANEL OVERVIEW

Main Panel Incubator Controls continued

Over Temperature Limit

The red Over Temp Activated light illuminates when the Over Temperature Limit system cuts off heating in the incubator by rerouting power away from the heating elements. While the OTL is rerouting power an alarm beep sounds a short alert every three seconds. The OTL control dial is located on the side shadowbox control panel. For more details, please see [the Over Temperature Limit System](#) description in the Theory of Operations (page 43).

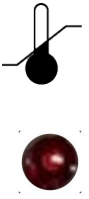

Workspace

Commission in Progress

This indicator illuminates while the automated Anaerobic Commissioning Cycle is active. The commissioning cycle launch switch is located on the shadowbox control panel.

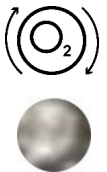

AMG Injecting

This illuminates while the BACTRON300 is injecting AMG into the workspace chamber.



Sleeves

Sleeve Cycle in Progress

The Sleeve Cycle light illuminates while the BACTRON300 is cycling the sleeves and armports.



Sleeve Cycle

The foot pedal switch launches the sleeve cycle. Momentarily pushing the foot switch initiates the cycle. Press the switch a second time to cancel the cycle.



Sleeve Pressure Display

The display shows the pressure in the sleeve assemblies. At room pressure, the gauge should read 0. During sleeve cycles, the pressure drops to -18inHg, then briefly backfills with AMG.

During normal operations when a cycle is not running, a pressure of +0.1inHg or higher on this gauge causes the BACTRON300 to open its chamber vent solenoid. This provides dynamic venting that helps prevent the manometer from bubbling (outgassing chamber atmosphere) while a user is working in the chamber, and displacing atmosphere within the sealed volumes with their arms.



CONTROL PANEL OVERVIEW

SHADOWBOX CONTROL PANEL

Located on the left side of the BACTRON300 behind a sliding door. This panel contains setting and backup manual controls that are typically not used during routine operations.

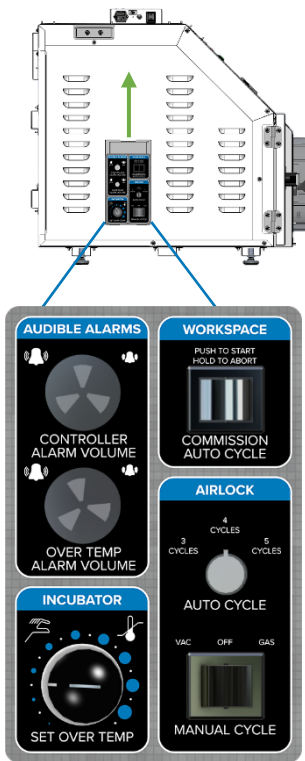

Manual Switch



The Manual Gas / OFF / VAC switch allows the user to manually cycle the airlock. This is a backup system.

Airlock Cycle Setting Switch



This switch sets the number of evacuations – gas backfill iterations for the airlock auto and manual cycles. The BACTRON300 comes set to 3 cycle iterations but can run 4 or five iterations.

Controller Alarm Volume



The top Audible Alarms dial sets the beep volume for the cycle abort alarms and the Low AMG warning alarm. The beep volume ranges from high to mute.

Over Temp Alarm Volume



The bottom Audible Alarms dial sets the beep volume for the Over Temperature Limit alarm. The volume ranges from high to mute.



Over Temperature Limit Control



On the BACTRON300 this dial sets the Workspace Chamber Incubator heating cut-off limit.

Commissioning Cycle Switch



Pressing this switch for up to 5 seconds launches the auto-timed Anaerobic Commissioning Cycle, purging oxygenated atmosphere from the chamber. Pressing and holding the switch for 5 seconds or longer again aborts the cycle.

BACTRON300 WORKSPACE INCUBATOR



Figure 7: BACTRON300 Workspace Incubator Control Panel

The workspace incubator control panel on the BACTRON300 controls the operations of the workspace chamber incubator and Over Temperature Limit (OTL) system.

Incubator Display

During normal operations, the display shows the current incubator air temperature, accurate to 0.1°C. The Up and Down buttons are used to change display modes and then input either a new temperature setpoint or a calibration adjustment. The display blinks continually while in its setpoint or calibration adjustment modes, preceded by an "SP" for Setpoint or "C O" for Calibration Offset.



The Heating indicator light illuminates when the BACTRON300 calls for power to the workspace chamber incubator heating elements.



Set Over Temperature

This graduated dial sets the heating cut-off point for the OTL temperature limit system. The OTL system prevents unchecked heating of the chamber in the event of a hardware failure or external heat spike. For more details, please see the [Over Temperature Limit System](#) description in the Theory of Operations (page 43).

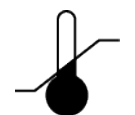

The red Over Temp Activated light illuminates when the Over Temperature Limit system cuts off heating by rerouting power away from the heating elements. An alarm beep sounds every 3 seconds while the OLT is rerouting power.



Over Temperature Alarm Volume

For the workspace incubator, located on the back of the control box.



This page left blank.

THEORY OF OPERATION

Achieving Anaerobic Conditions

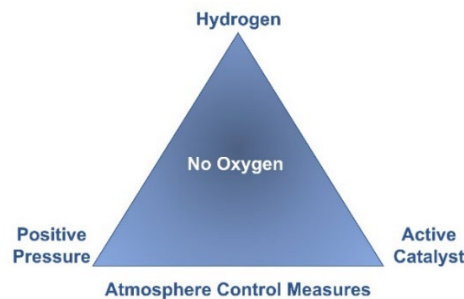

Figure 8: Atmosphere Control Measures

The BACTRON300 is engineered to establish and maintain an anaerobic workspace chamber atmosphere suitable for clinical cultivation of anaerobic bacteria. This atmosphere is initially achieved by purging the chamber with pulses of anaerobic mixed gas (AMG) as part of an auto-commissioning cycle. The AMG purge pushes standard (free) atmosphere out through a vent solenoid controlled by the cycle.

In addition to the AMG pulses, an O₂ scrubber inside the chamber captures oxygen through a catalytic reaction between the AMG hydrogen, any free oxygen, and the palladium-coated pellets in the scrubber cartridge. This reaction forms water vapor (H₂O).

Catalysis is the process of increasing the rate of a chemical reaction by adding a substance known as a catalyst. Catalysts are not consumed in the reaction and remain unchanged after it. In the BACTRON300, the catalysis is an exothermic process, and the scrubber cartridge body will grow hot to the touch in the presence of free oxygen and hydrogen.

After completion of the auto-commissioning cycle, the O₂ scrubber maintains the anaerobic atmosphere in the chamber. Each O₂ scrubber must be removed after 24 hours of use and reactivated by baking the cartridge at 200°C for 8 hours. This removes buildups of hydrogen sulfides and fatty acids from the palladium surfaces of the scrubber pellets.

A mild overpressure in the chamber is established with AMG injections to prevent the infiltration of external aerobic atmosphere, including the diffusion of molecular oxygen through seals.

Oxygen intrusion surveillance is conducted using color-changing Oxoid brand indicator strips. Microbiological controls, such as *Clostridium novyi* or *Pseudomonas aeruginosa*, may also be used to indicate anaerobic or aerobic conditions. A digital oxygen detector is available for purchase for real-time readings and logging.

Condensate Management

Evaporation from Petri dish sample media and water vapor from the catalytic scrubber reaction are captured on the cold plate of a Peltier-effect condensate chiller located behind the O₂ scrubber cartridge. This condensed moisture is then channeled into a drain tube that empties into a receptacle placed in the workspace chamber by the end-user. The receptacle must be drained regularly. The Peltier condensate chiller eliminates the need to use chemical desiccants which can retain condensate and dry out culture media.

Accessing the Workspace Chamber

The BACTRON300 airlock is used to introduce or remove sample containers and laboratory equipment from the workspace chamber. The airlock creates a near anaerobic environment through partial vacuum evacuations to reduce the atmospheric volume, followed by anaerobic gas backfills. Each evacuation phase draws the airlock down to -18 inches of mercury (inHg), removing approximately 60% of the O₂ in the airlock while retaining enough pressure to prevent sample media from boiling. The number of evacuations – backfill iterations can be set by the user to 3, 4, or 5. More iterations use more gas and require more time but achieve a lower end-state oxygen residual in the airlock chamber. Residual oxygen is captured in the workspace chamber by O₂ scrubber catalyst, which is located in close proximity to the inner airlock door and the chamber circulation fan.

A backup control to manually cycle the airlock is located on the shadowbox control panel.

Users can access and work glove-free in the anaerobic workspace chamber using the armports and attached sleeves on the front of the BACTRON300. The user dons both sleeves and initiates a cycle of the sleeves by pressing the foot pedal switch once. Upon completion of the cycle, the user opens the armport doors and enters the chamber. The automated sleeve cycle consists of two vacuum down/AMG backfill iterations.

Cycling and effective use of the sleeves require bare skin contact between the widest part of the user's forearms and the cuff ring of the sleeve body. Smooth small items held by hand may be introduced into the workspace chamber through the sleeves. The sleeves are compatible with exam gloves for handling pathogenic samples.

Incubators

The BACTRON300 is provided with a side-storage incubator adjacent to the workspace chamber.

The incubator is controlled by a microprocessor board with a solid-state temperature sensor probe attached to the incubator body, along with two heating elements. The processor employs proportional-integral-derivative (PID) analytical feedback-loop functions when measuring and controlling the chamber air temperature. PID-controlled heating pulse intensities and lengths are proportional to the difference between the measured chamber temperature and the setpoint. The setpoint is the desired operating temperature entered by the user. The frequency of pulses is derived from the rate of change in the difference. The integral function slows the rate of pulses when the temperature nears the setpoint in order to prevent overshooting.

The PID functions are also used to optimize incubator warming rates for hotter or cooler environments. If the BACTRON300 is moved to a new location with a significant temperature difference, it may require 24 hours of incubator runtime for the processor to fully adapt to the new thermal environment. To verify the temperature display accuracy, the incubator should run at its application setpoint for 24 hours before loading samples. The heat loss from leaving the incubator doors open for long periods (an hour or more) can trick the controller into operating as though in a cool environment. This can result in a phase of temperature overshoots.

The incubator relies on natural heat radiation for cooling. An incubator can achieve a low-end temperature of the ambient room temperature +5°C. The fan inside the incubator aids in maintaining air circulation and a uniform air temperature in the incubation space.

The Over Temperature Limit (OTL) System

The OTL is a mechanical heating cutoff included with each incubator and operates independently of the incubator microprocessor controller. The OTL helps safeguard samples by preventing runaway heating in the event of a hardware failure in the microprocessor controller or a sudden external heat spike. The OTL is connected to a hydrostatic sensor probe located inside the incubator and is intended to be set by the user to approximately 1°C above the current operating temperature setpoint.

If the incubator temperature exceeds the OTL cutoff setting, the OTL will route power away from the incubator heating elements. It will continue to do so when the incubator air temperature is higher than the present OTL cutoff setting. While the OTL is rerouting power, a red indicator illuminates, and a short alarm beep sounds every 3 seconds.

Manometer Pressure Gauge and Check Valve

The water-filled manometer in the workspace chamber serves as a visual pressure gauge and dynamic venting check valve during instances of excess overpressures. The manometer is filled to the top reference ring when the chamber unpowered and at room pressure. When the BACTRON300 is powered, the chamber is under pressure which forces the water down to 0.5 inch from the bottom reference ring.

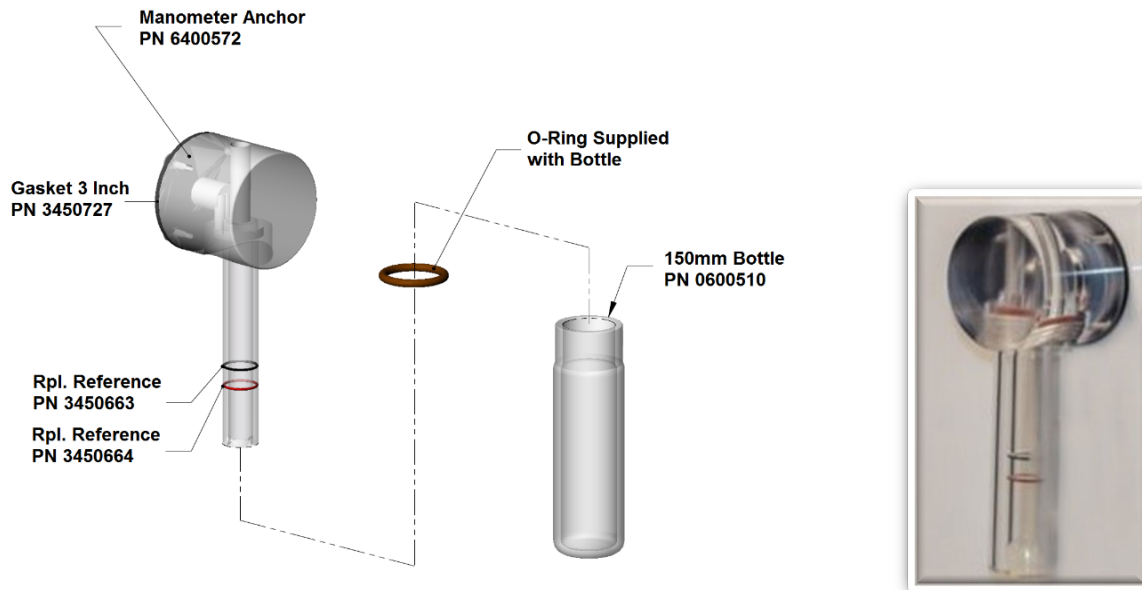

Figure 9: Chamber Manometer

Additional pressure increases inside the workspace chamber to drive the water farther down into the manometer bottle. Excessive pressure will cause the water to bubble as the chamber atmosphere is vented through the manometer water and out of the chamber. This helps to prevent damage to the chamber gaskets and the acrylic glass panels. The manometer exhaust vent is a port consisting of a tube and black O-ring located on the back, right side of the BACTRON300.

Additional venting is provided by the armpoint sleeve solenoid whenever the sleeve pressure gauge detects a pressure level of +0.1inHg or higher in the sleeve assemblies.

PUT THE BACTRON300 INTO OPERATION

Note: Once in operation, the BACTRON300 should run for **24 hours** prior to loading samples. This ensures the stability of both the anaerobic atmosphere and incubator air temperature.

After installation in a new workspace environment, check the following items prior to placing the unit into operation.

1. Verify all Installation procedures have been carried out.
2. Verify enough AMG is on hand to commission and sustain an anaerobic atmosphere.
3. Verify that an active O₂ scrubber is ready to install in the workspace chamber.
 - The catalytic O₂ scrubbers come from the factory activated and ready for use.
 - If the scrubber cartridge has been stored for 6 months or longer, bake out the scrubber cartridge for at least 8 hours at 200°C to reactivate the catalytic palladium.

Perform the following procedures and steps

1



Perform the **Install the O₂ Scrubber** procedure on page 47.

2



Perform the **Plug in the BACTRON300** procedure on page 47.

3

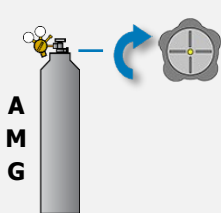

Perform the **Supply Gas to the BACTRON300** procedure on page 48.

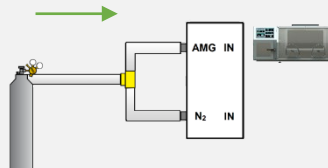

4

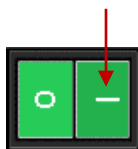

Place the Power Switch on the Main Control Panel in the On (I) position.

- The switch and control panel displays will illuminate.

5

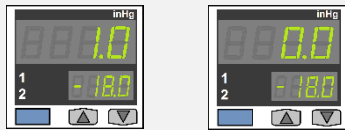

Zero the Pressure Displays if the BACTRON300 has been installed in an overpressure environment or at a high altitude. This sets the pressure gauges to local conditions. See page 49.



Leave the incubator Set to Off

Each BACTRON300 incubator comes from the factory set to OFF and must remain off during the auto commissioning cycle. The incubator display shows a temperature near that of the ambient environment when off.

If the incubator has been turned ON, see the **Set the Incubator Temperature** on page 58 for how to set an incubator to OFF.

6

Commissioning Cycle



Perform the **Launch the Anaerobic Commissioning Cycle** procedure on page 50. The cycle takes approximately **5 hours** to complete for the BACTRON300.



7

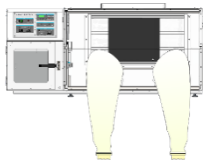

Attach the Sleeves to the armports, page 51.



8

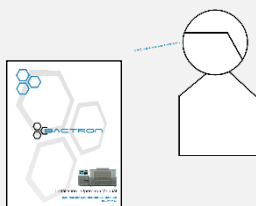

Read

Review the following procedures while the commissioning cycle establishes an anaerobic atmosphere. The user's hands will be occupied in the sleeves while working in the chamber after the cycle is complete.

- **Enter the Chamber** page 52
- **Moving in the Chamber** page 54
- **Anaerobic Monitoring Strip** page 55
- **Verifying the Anaerobic Atmosphere** page 56
- **Troubleshooting O₂ in the Chamber** page 56
- **Exit The Chamber** page 57



9

Commission in Progress

Commissioning Cycle Finishes

- The Commissioning cycle light will flash three times, then extinguish.

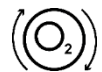

10

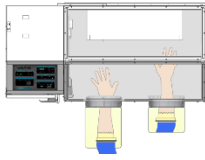

Enter the Chamber after the commissioning cycle has finished, page 52.

11

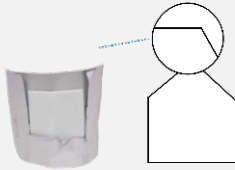

Verify the Anaerobic Atmosphere, page 56.

If the chamber is not fully anaerobic perform the **Troubleshooting O₂ in the Chamber**, page 56.

12

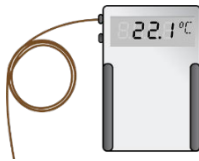

Optional: If you are required to verify the accuracy of the incubator temperature display(s), set up the verification equipment now.

See the suggested calibration setup and the first two steps of the suggested **calibration procedure** on pages 80 and 81.

13

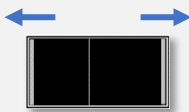

Close the incubator doors.

- If you have set up temperature probes in the incubator(s) to run a verification or calibration, make sure any gaps created by the probe wires are covered.

14



Set the incubator to your application temperature. Please see the **Set the Incubator Temperature** procedure on page 58.

15



24 Hours Required

Allow the BACTRON300 to run 24 hours prior to:

- **Loading Samples**, page 63
- Verifying or calibrating the accuracy of the incubator temperature display.

16

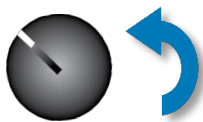

Set the Over Temperature Limit heating cutoff temperature on page 58.

BACTRON300: The OTL system for the incubator must be set separately.

Step 16 concludes the Putting the BACTRON300 into Operation procedure.

OPERATION

INSTALL AN O₂ SCRUBBER CARTRIDGE

Open the left armport door, install one O₂ scrubber cartridge, then close and latch the armport door.

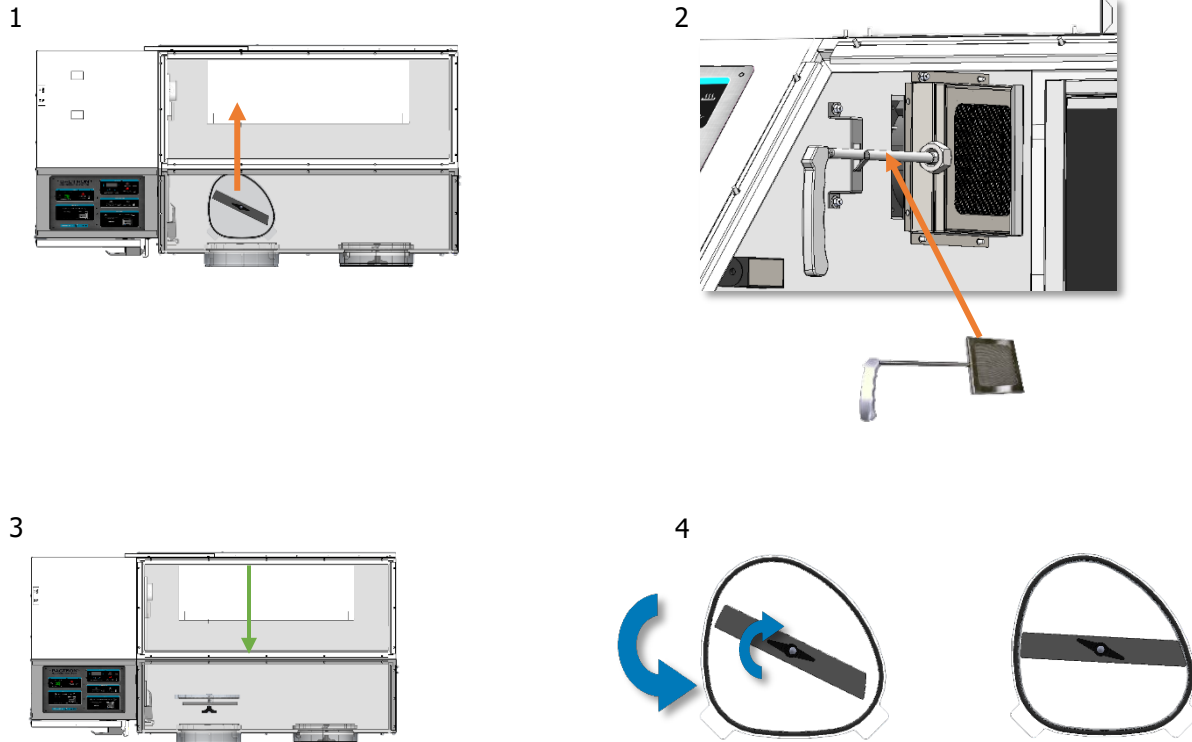

See page 31 for instructions on **Properly Closing and Latching the Armport Door**. Whenever the chamber is anaerobic, scrubbers should be introduced and removed through the airlock.

PLUG IN THE BACTRON300

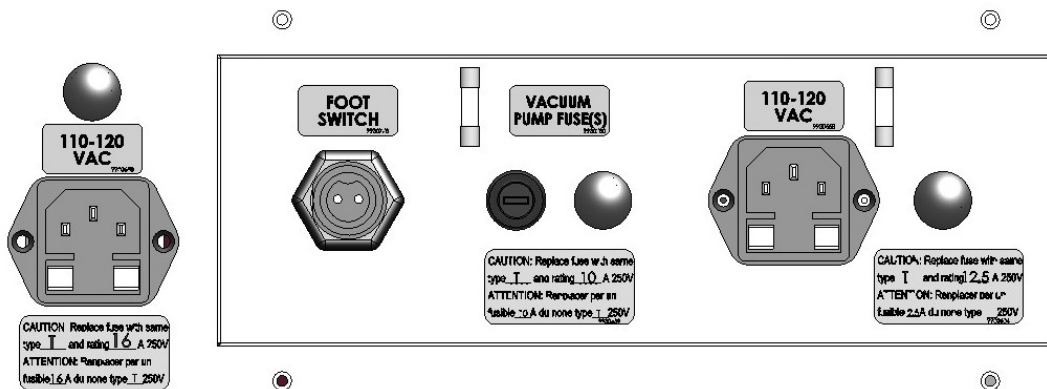

All Units

SUPPLY GAS TO THE BACTRON300

1. Open the supply cylinder valve.

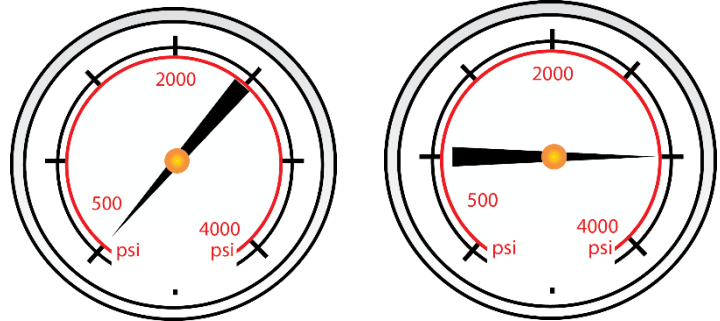
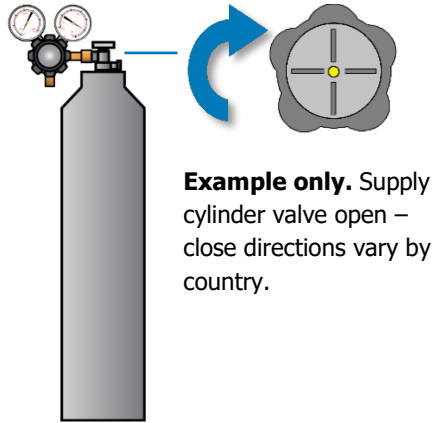

2. Open the Regulator Flow Valve to supply an AMG flow of 50 psi to the BACTRON300.

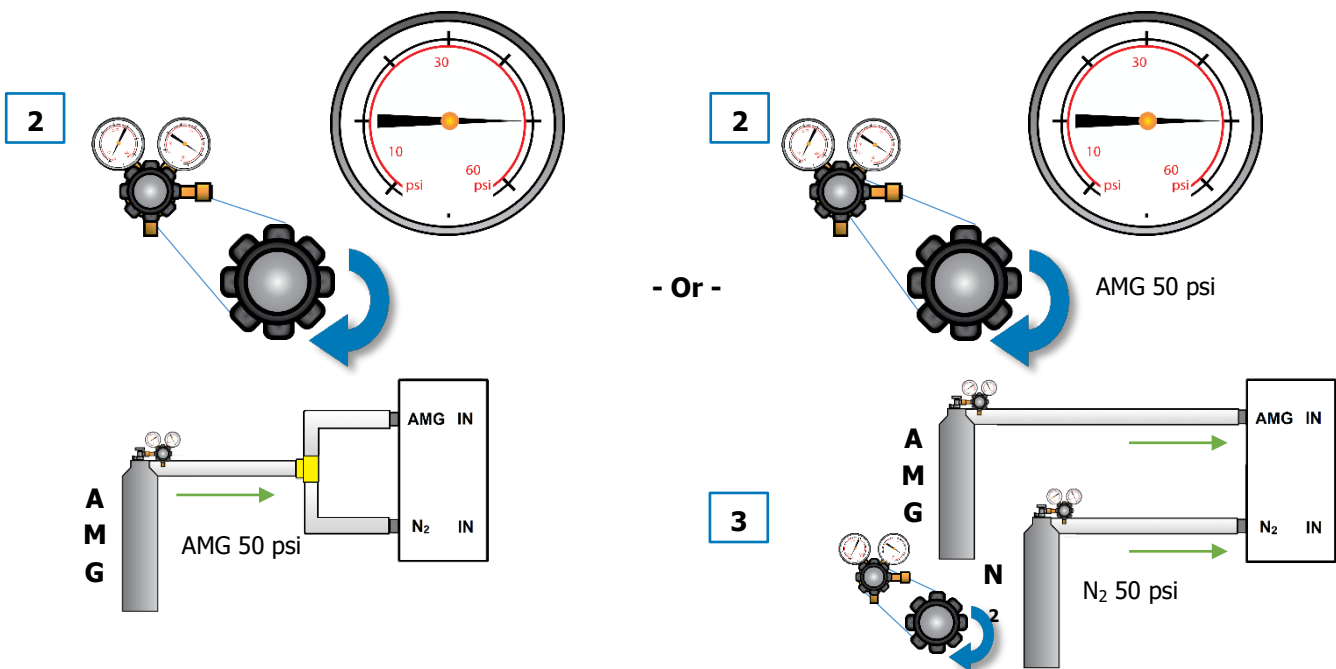

3. **Optional:** Open the Nitrogen regulator valve to supply a N₂ flow of 50 psi to the BACTRON300 N₂ port.

ZERO THE PRESSURE DISPLAYS

Conditional: This procedure should always be performed on BACTRON300s installed in overpressure environments, and may also need to be performed on units installed in high-elevation locations 5,000 feet (2,000 meters) above sea level or higher.

Function: The Airlock and Sleeve Pressure Displays on the main control panel should each show 0 (zero) when exposed to room atmosphere pressure. The gauges help restore the airlock and sleeves to near room pressure when completing a cycle. The gauges were originally zeroed near sea level.

Sleeve Pressure Display

Zero the Sleeve display **if** the display shows a reading other than 0 **when sleeves are not attached** to the armports.

1. Always remove the sleeves from the armports prior to zeroing.
2. Press and hold **both** the up and down buttons until the display shows zero.

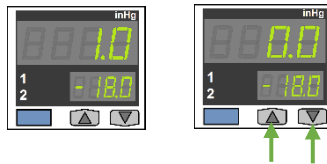

Airlock Pressure Display

Zero the Airlock display **if** the display shows a reading other than 0 **when the outer airlock door is open**, exposing the airlock chamber to room pressure atmosphere.

1. Open the outer airlock door.
2. Press and hold **both** the **up and down buttons** until the display shows zero.
3. Close and latch the door after zeroing the display.

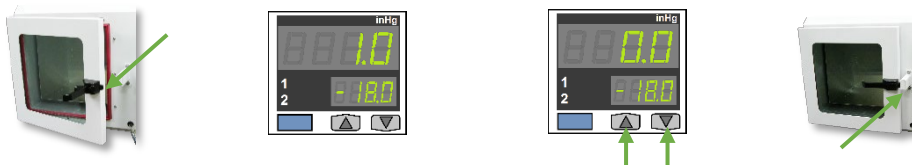

OPERATION

LAUNCH THE ANAEROBIC COMMISSIONING CYCLE

The cycle establishes an anaerobic atmosphere in the workspace chamber over the course of several hours.

Note: Commissioning cycles will not initiate while a sleeve cycle or an airlock cycle is active.

1. Prior to launching the cycle, verify that: **Incubator** is set to **OFF**



2. Launch the Commissioning Cycle:



Briefly, press the **Commission Auto Cycle** button on the side shadowbox control panel.

- The Commission in Progress light on the main control panel will illuminate and remain on throughout the cycle.
 - The BACTRON300 requires **5 hours** to complete the cycle.

During the cycle, extended AMG injections force aerobic chamber atmosphere out through a one-way commissioning solenoid. This purge and the O₂ capture provided by the oxygen scrubber removes O₂ from the chamber atmosphere.

- Sleeve cycles and airlock cycles will not initiate while commissioning is active.
- Upon completion of the Commission Auto Cycle, the Commission in Progress light will blink three times and extinguish. The commissioning solenoid port closes automatically.

Fogging and Humidity. Mild or heavy condensation may take place inside the chamber during the cycle. This is due in part to the formation of water vapor as the catalytic O₂ scrubber removes large amounts of oxygen. High ambient humidity and cool room temperatures also contribute. The condensate should dissipate by the end of the cycle as oxygen decreases and as the condensate controller removes water vapor from the chamber atmosphere.

Aborting the Commissioning Cycle

If it is necessary to abort the commissioning cycle, press and hold the Auto Commissioning Cycle switch for 5 seconds.



ATTACH THE SLEEVES

Attach and secure both sleeves to the armports. This allows reach-in access to the chamber through the ports without introducing aerobic external atmosphere.



Figure 9: Sleeve Installation

Begin with either Armport

1. Unroll the large opening of a sleeve over the lip of the armport door. Beginning from the bottom of the armport is typically the easiest approach.
 - Place the ring on the large end of the sleeve inside the groove on the armport.
 - Make sure none of the sleeve material is trapped or pinched between the ring and the seating groove.
2. Secure the sleeve to the armport using the 48 inch (121 cm) self-gripping strap included with the sleeve.
 - Exercise caution when placing the strap next to the armport gas lines.
3. Repeat the process for the second sleeve and armport.

Note: Sleeves may remain attached to the BACTRON300 when not in use.

ENTER THE CHAMBER

Prior to entry, read the [Exiting the Chamber procedure](#) (page 57) for how to withdraw your arms from the chamber without compromising the anaerobic atmosphere.

1. Don the Sleeves

Note: Sleeves come with mid-sized, size 8 cuffs. Please see the Parts List on page 88 for other cuff sizes.

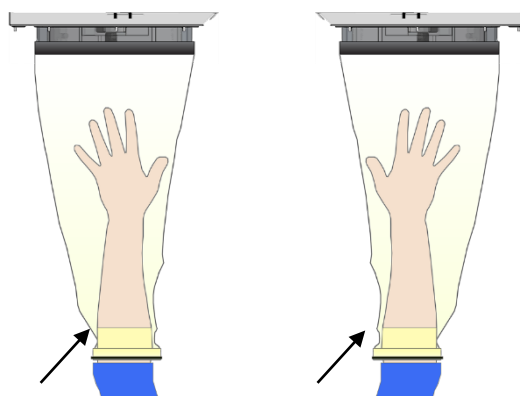

Snug contact, sleeve cuff and bare skin at the widest part of the forearm.

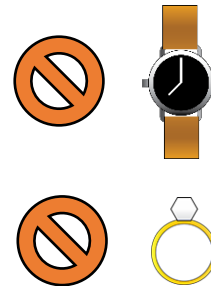

Remove rings and watches. Sharp objects will damage the sleeves.

2. Position and hold your hands approximately 4 – 6 inches (10 cm – 15 cm) away from the arm port doors, to either side.

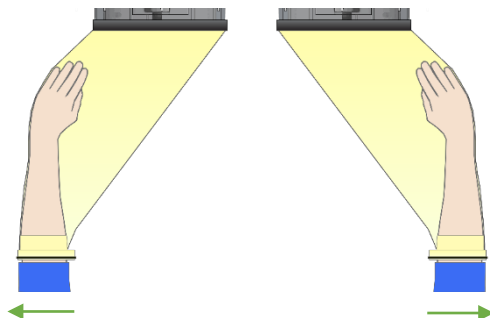

This position prevents the collapsing sleeves from pulling your hands into the arm port doors during the vacuum down cycle phases. It also keeps the sleeve material tight, helping to obtain a complete evacuation of the sleeves.

3. Cycle the Sleeves



- a. Press and release the foot pedal.
 - Both sleeves will vacuum down then partly fill with AMG twice.

Cancelling the Sleeve Cycle: Press the foot pedal at any time to end an active sleeve cycle.

Auto Abort Signal: The Auto Abort Signal is an audio alarm of a long beep, followed by a short beep sound. The sleeve cycle light flashes in the event of an auto abort.

Auto Abort 1: The cycle will abort if a vacuum down phase fails to achieve -18inHg within 25 seconds. Check the sleeves for leaks and ensure that the sleeves are properly attached.

Auto Abort 2: The cycle aborts if the cycle injects AMG into the workspace chamber twice during a sleeve cycle vacuum phase. Check that the arm port doors are properly sealed and latched to prevent the sleeve cycle from vacuuming atmosphere out of the chamber.

4. Open the Armport Doors

a.



When the cycle has finished, loosen both armport doorknobs by 2 or 3 turns.

b.



Rotate the locking bars to roughly 45°.

c.

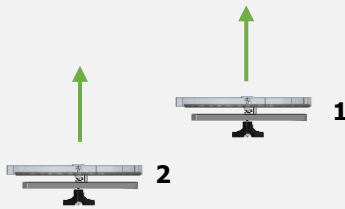

Slowly push one door into the chamber, then slowly push the other door into the chamber.

Pushing both doors in simultaneously will create a significant displacement of the pressurized chamber atmosphere, resulting in active venting.

5. Store the Arm Port Doors

Leave doors open for commissioning cycle
(Doors should be centered)

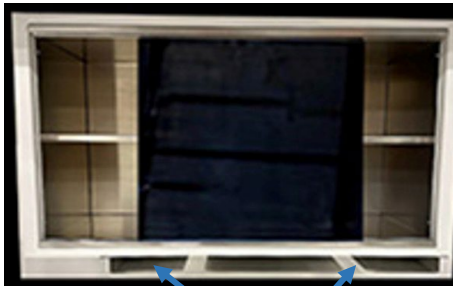

Arm Port Doors and Storage



OPERATION

MOVING IN THE PRESSURIZED CHAMBER

Undisturbed Overpressure

When sealed and sitting undisturbed, the BACTRON300 maintains 0.5 inches (1cm) of water column overpressure in the workspace chamber to prevent infiltration by external atmosphere.

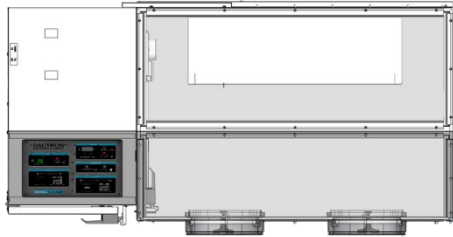

0.5 inches (1cm) water column overpressure

Pressure Increase

Introducing objects into the sealed chamber displaces atmosphere, further increasing the pressure. The BACTRON300 will vent atmosphere through a pair of one-way valves to avoid damage to the chamber.

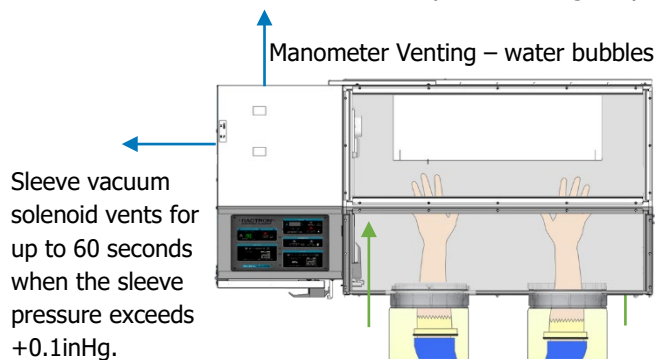

Reminder: Approximate volume of displaced chamber atmosphere is equivalent to inserted arms.

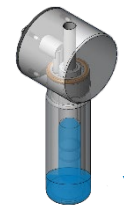

Water in the manometer's outer bottle forced down.

All vented atmospheres will be replaced with injected AMG after the displacement ends. This drives up the overall AMG usage and associated operating costs.

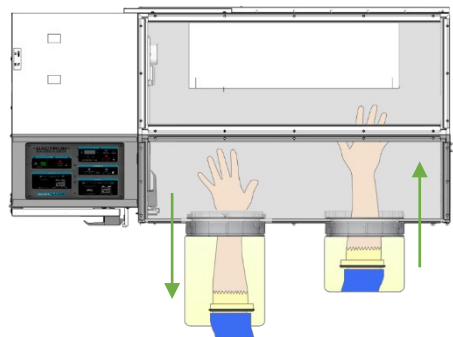

Pressure Management

- Slow, deliberate, simultaneous movements balancing out one another.
- No atmosphere vented.

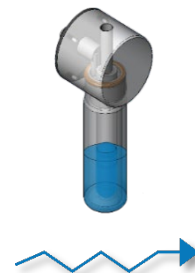

Use a swimming motion, withdrawing one arm while reaching in with the other. Slow movements avoid spiking the chamber pressure and venting anaerobic atmosphere.

VACUUMING DOWN BALLOONING SLEEVES

The foot pedal switch may be used to vacuum down the sleeves if the sleeves balloon up when working in the workspace chamber.

1. Tap the foot pedal switch once to begin vacuuming down.
2. Tap the foot pedal again when the sleeves have collapsed far enough to work comfortably.

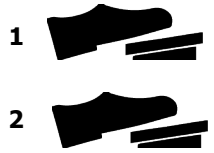

Note: If the foot pedal is not pressed a second time, the BACTRON300 will run through a complete sleeve cycle.

ANAEROBIC MONITORING STRIPS

An anaerobic monitoring strip packet must be opened to verify a strict anaerobic atmosphere has been established in the chamber following the commissioning cycle.

An open strip must be present at all times in the chamber during normal operations to monitor for oxygen contamination.

Handling and Placing the Strips

- **Do not touch the monitoring strip body.** Doing so risks contaminating the strip and creating false oxygen positive coloring, even in a fully anaerobic environment.
- A dried-out monitoring strip will not indicate new oxygen contamination. A new strip must be opened in the chamber every 24 hours.
- Place the strip where it will be clearly visible.
 - **Do not place the strip in an incubator.** Accelerated drying and heat discoloration may generate false positive readings.
- For best accuracy and to lengthen the amount of usable time, the strip should be left in the packet, partly exposed. This avoids contamination and wicks oxygen-detecting fluid up from the bottom of the packet.
 - Bend the edges or partly fold the packet to allow it to stand upright.
- The strips **do not lose color after having been exposed to significant O₂.** A strip holds its pink coloration once completely saturated, even if the oxygen is removed from the chamber atmosphere.
 - A new packet must be opened to resume monitoring for O₂ once all oxygen is purged or scrubbed from the chamber atmosphere.



Note: A digital gas analyzer capable of detecting oxygen may be used to verify an anaerobic atmosphere has been established. Use the airlock to introduce the analyzer into the workspace chamber after the commissioning cycle is complete.

VERIFY THE ANAEROBIC ATMOSPHERE

1. Enter the workspace chamber using the Entry procedure, cycling the sleeves.
3. Open 1 oxygen strip near the center of the chamber.
4. Wait 1 minute. Observe the strip handling precautions listed on page 55.



White
Anaerobic



Moderate Pink
Heavy O₂



Very Pale Pink
Slight O₂



Saturated Pink
Fully Aerobic



Light Pink
Mild O₂

5. If the strip remains white, the chamber is anaerobic. Exit the chamber using the steps in the Exit the Chamber procedure on page 57. **The verification procedure is complete** on page 56.
 - Leave the strip in the chamber to monitor for oxygen intrusions.

– Or –

6. **If the strip turns partly or completely pink**, exit the chamber using the **Exit the Chamber** procedure.
7. Launch another BACTRON300 commissioning cycle to purge oxygen and introduce more AMG for the scrubber to remove O₂.
 - Allow the cycle to run for 1 hour.
8. Abort the commissioning cycle after 1 hour.
9. Reenter the chamber using the Entry procedure and open 1 anaerobic monitoring strip.
10. If the strip remains white, the chamber atmosphere is anaerobic and ready to use. Exit the chamber using the steps in the Exit the Chamber procedure.
 - Leave the strip in the chamber to monitor for oxygen intrusions.

– Or –

11. If the second strip turns pink, exit the chamber, and perform the **Troubleshooting Oxygen in the Chamber** procedure on page 69.



Wait 1 Hour

EXIT THE CHAMBER

Pressure in the chamber drops when a user withdraws their arms. If done too quickly, this can draw in outside air through the sleeve cuffs or manometer. Use the following steps to exit the chamber without pulling in aerobic atmosphere.

1. Check that both airlock doors are closed and latched to avoid drawing aerobic atmosphere in through the airlock.
2. One at a time, remove armport doors from storage and place them on the chamber floor in front of the ports.
3. Close and latch the armport doors.
 - See the [Install the Armport Doors](#) procedure on page 30 for how to correctly latch the armport doors.
4. Withdraw your arms from the sleeves one at a time.

Armport Seal Check



1. Grip and **slowly** push **both** sleeves simultaneously towards the doors. This will cause the sleeves to balloon.
 - If the manometer water bubbles in response or the outer ring of water moves down, one or both armport doors are not sealed.
 - The armport vacuum solenoid will click and passively vent atmosphere from the sleeve assemblies responding to the pressure increases in the sleeves, even if the doors are sealed correctly.
 - **Do not physically press on the armport doors to test the seals!** Doing so routinely may warp the acrylic glass front panel or damage the doors and armports.
2. If the armport doors are not correctly sealed, don and cycle the sleeves, then reseal and relatch the doors.

SET THE INCUBATOR TEMPERATURE SETPOINT

Close the incubator doors prior to setting a temperature setpoint. Running the incubator for longer than a half hour will result in temperature instability and overshoots once the doors are closed.

BACTRON300: The incubator must be set independently.

1. Set OTL control to its maximum setting, if not already set to max.

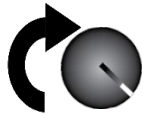

- Turning the OTL all the way to the right (clockwise) prevents the heating cutoff system from interfering with this procedure.

2. Jump to the Temperature Setpoint Adjustment mode



Set Temperature



Setpoint Adjustment Mode

Set



Initial Setpoint+

Press and hold either

Note: The display will automatically exit the adjustment mode after 5 seconds of inactivity on the arrow keys, saving the last shown setpoint value.

3. Set the Temperature Setpoint

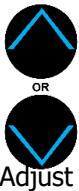

New Setpoint

Note: To turn an incubator off, set the setpoint to its lowest setting (OFF).

4. Wait for 5 seconds after entering the Setpoint



Wait 5 Seconds

Set Temperature



HEATING ACTIVATED

- The display will stop flashing. The setpoint is now saved in the controller.
- The display will revert to showing the current chamber air temperature, heating or passively cooling to match the new setpoint.

See the next page for how to [Set the Over Temperature Limit](#) heating cutoff.

End of procedure

Note: Test the OTL heating cutoff system at least once each year for functionality.

SET THE OVER TEMPERATURE LIMIT

The incubator must be operating at your incubation application temperature and must be stable for at least 1 hour prior to setting the OTL. The incubator OTL must be set independently in the BACTRON300.

1. Set OTL control to its maximum setting, if not already set to max.

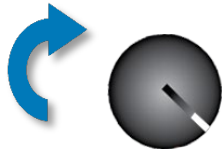

2. Turn the dial counterclockwise until the red Over Temperature Limit Light illuminates.

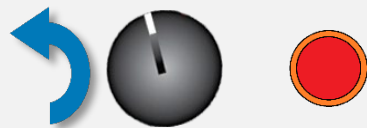

3. Slowly turn the dial clockwise until just after the OTL Activated light turns off.



- The Over Temperature Limit is now set approximately 1°C above the current incubator air temperature.

4. Leave the OTL dial set just above the activation point.



Optional: Turn the dial slightly to the left.



- This sets the OTL cutoff threshold nearer to the current incubator air temperature.

If the OTL is sporadically activating, you may turn the dial very slightly to the right (clockwise).

If the OTL continues activating, check for ambient sources of heat or cold that may be adversely impacting the unit's temperature stability. Check to determine if any powered accessories in the workspace chamber are generating heat. If you can find no sources creating external or internal temperature fluctuations, contact Tech Support or your distributor for assistance.

End of Procedure

OPERATION

SET THE AIRLOCK CYCLE ITERATIONS

Optional: The BACTRON300 comes from the factory set to run a 3-iteration auto cycle. The airlock can be set to run 4- or 5-iteration cycles. Each cycle iteration consists of a vacuum down evacuation phase followed by a gas backfill of the airlock chamber. More iterations decrease the amount of O₂ left in the airlock chamber upon cycle completion but increase gas usage and cycle run times.

- BACTRON300:
 - 3 cycle iterations, 46 seconds
 - 4 iterations, 60 seconds
 - 5 Iterations, 72 seconds.



Figure 10: Shadow Box Control Panel

CYCLING THE AIRLOCK

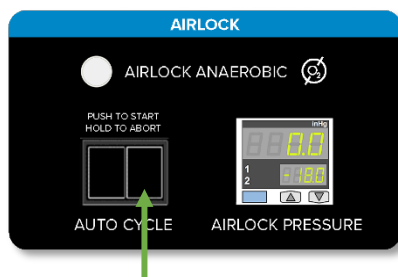
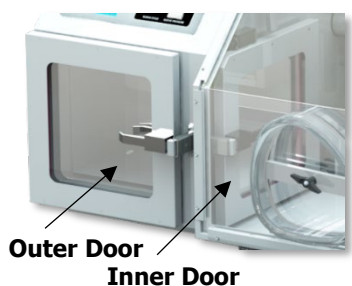

Light On. The airlock has been cycled. Inner airlock door unlocked.



Light Off. The outer airlock door has been opened allowing O₂ into the airlock. Inner door is locked.

Cycle the airlock prior to opening the inner airlock door whenever the Airlock Anaerobic light is off.

1. Close and latch both the inner and outer airlock doors, or the airlock will not cycle.
2. Push the Airlock Auto Cycle switch on the main control panel.
 - The airlock evacuates down to -18inHg then backfills with gas drawn from the **N₂ In** port to -4inHg during all but the final cycle iteration.
 - The airlock backfills to a positive pressure drawing from the **AMG In** Port during the final gas backfill. The Airlock Anaerobic light turns On.
 - **The inner airlock door unlocks during the final gas backfill.**

The inner airlock door locks automatically when the outer airlock door is next opened.

Always close airlock doors after loading or offloading items. This safeguards against an inattentive user opening the outer door while the inner door is open.

Aborting an Active Auto Cycle

1. Press and hold the Auto Cycle switch to the right for **2 seconds**.
 - The BACTRON300 will cease vacuuming and automatically restore pressure to the airlock.

Simultaneous Cycles

Cycling the armports while cycling the airlock slows the airlock cycle.

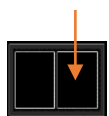
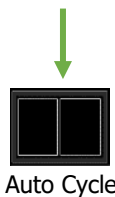

MANUALLY CYCLING THE AIRLOCK

This control is intended as a backup for the airlock autocycle system. It can also be used to carry out custom cycles or low-pressure applications down to -18inHg in the airlock chamber.

Unlocking: The inner airlock door will unlock when the chamber has been vacuumed down a number of times equal to:

- The Auto Cycle selector switch setting when the last autocycle was run; **or**,
- **The door unlocks** after the last autocycle when **the** BACTRON900 is turned off. The airlock vacuums down a number of times equal to the switch setting when the unit is turned back On.

Both airlock doors must be closed and latched. The airlock will not manually cycle if either door is open.

1. Press the Manual Cycle switch to the left (VAC).
 - The airlock will draw down to -18inHg pressure and then cease vacuuming.
 - You may stop the vacuum down at any time by returning the switch to the middle position.
 - Stop the vacuum draw down immediately if the water in the manometer gauge bubbles or the AMG Injecting light illuminates frequently indicating there may be a leak along the inner airlock door.
2. Press the Manual switch to the right (GAS) to inject AMG into the airlock.
 - The airlock will backfill with AMG, restoring it to near room atmosphere pressure.
 - You may stop the AMG backfill at any time by returning the switch to the middle position.
 - This completes one cycle iteration.
3. Run a number of cycle iterations, repeating Steps 1 and 2, equal to the number of iterations run during the last autocycle.
 - The inner airlock door unlocks when the Manual Cycle switch is returned to the middle position after completing the final vacuum down for the cycle.



MANUAL

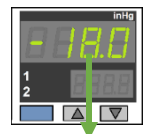

AIRLOCK SAFETY ABORTS

An auto cycle will abort under the following conditions.

- If either airlock door is opened during the cycle.
- If the Low AMG alarm activates.
- If the vacuum pump has been running continuously for 90 seconds.
- If an auto cycle fails to achieve a pressure lower than -4inHg in the airlock chamber within 10 seconds during a vacuum down phase.
 - This safeguards against any leaks in the airlock door seals drawing in external aerobic air or workspace chamber atmosphere.

In the event of an aborted auto cycle, a long beep followed by a short beep will sound, the Airlock Anaerobic light will flash, then extinguish.

VACUUM PUMP COOLDOWN LOCKOUT

The BACTRON300 will stop running the vacuum pump after 90 consecutive seconds of operation. This safeguards against overheating the pump in the event of a leak in the workspace chamber, airlock, gas plumbing, or other hardware failures. This cooldown lockout lasts for five minutes during which the airlock and sleeve cycles will not run.

Normal vacuum applications in BACTRON300 cycles require runtimes significantly shorter than 90 seconds.

If the pump is in a lockout state, check for leaks in the workspace chamber and airlock.

INNER AIRLOCK DOOR LOCK

Locking

The inner airlock door automatically locks when the outer airlock door is opened or when the BACTRON300 is turned On.

Manual Unlock

To unlock the inner airlock door without manually cycling or auto cycling the airlock:

- Rapidly cycle the Manual Cycle switch from GAS to VAC a number of times equal to the setting of the Auto Cycle switch when an auto cycle was last run.
 - **Or**, if the BACTRON300 has been turned Off, equal to the setting of the Iteration switch when the unit was turned On.
 - **Or**, the lock can also be physically unlocked by pressing the small silver stud on the lock, just above the inner airlock door latch. The back of a pen or other narrow, blunt object is recommended.

LOADING SAMPLES

The manufacturer recommends waiting 24 hours after establishing an anaerobic atmosphere before loading samples into the unit.

Containers

Airtight containers can introduce significant amounts of oxygen into the anaerobic environment of the BACTRON300.

- Whenever possible, closed containers placed in the airlock should be loose-capped or ventilated to allow the airlock cycles to draw oxygen from the containers.
- Caps on empty syringes should be loosened if permitted by your laboratory or production protocol.

Sliding Shelf Transport

The airlock sliding shelf can hold and transport up to 216 plates.

Incubator Sample Placement

- Even spacing. Place samples and other media containers as evenly spaced as possible on the incubator shelves to allow for atmosphere circulation and better temperature uniformity.
- Humidifying. Placing an open beaker of water on the left side of the circulation fan on the bottom shelf of the workspace incubator in the BACTRON300 will help prevent samples from drying prematurely.
- If anaerobes sensitive to heat are being cultivated, it may be necessary to place an empty Petri plate at the bottom of each stack of the workspace incubator.

This concludes *Putting the BACTRON300 into Operation* portion of the Operation Section.

HUMIDIFYING THE INCUBATORS

Placing a small number of Petri dishes or other open media containers in the BACTRON300 for several weeks may lead to excessive drying of sample media. A small open container such as a flask of 500ml of distilled water set on each shelf of the incubator can help to slow sample drying.

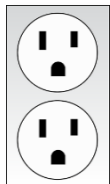

CHAMBER ACCESSORY POWER OUTLETS

BACTRON300s are equipped with accessory outlet(s) located inside the workspace chamber on the left wall. 230V versions of BACTRON300s are provided with one accessory outlet, while 115V versions have two. The power switch on the main control panel controls power to these outlet(s).

- The outlets are intended to power low-draw equipment such as magnetic stirrers or a volatile compounds scrubber fan.
- **Do not attach equipment drawing more than 1 amp from both outlets.**

Waste Heat

Accessory equipment may heat the workspace chamber. This can affect the temperature performance of the incubator and may increase pressure in the sealed chamber through thermal expansion of the chamber atmosphere. Monitor the chamber pressure using the manometer and the incubator performance when using powered accessories inside the workspace chamber.

VOLATILE COMPOUND SCRUBBER AND REJUVENATION CYCLE

Activated carbon scrubber media may be placed in the workspace chamber to absorb volatile fatty acids and volatile sulfur compounds produced by sample cultivation. Scrubbing out volatiles reduces odors, reduces the filmy buildups on chamber surfaces, and prolongs O₂ scrubber endurance during cultivation processes producing significant amounts of VFAs (volatile fatty acids) or VSCs (volatile sulfur compounds).

Please see the [Accessories section](#) on page 90 for information on scrubber media recommended by the manufacturer.

Use and Rejuvenation:

1. Place a 250-gram sample (one packet) of media in a 500ml beaker. Place another 250-gram sample into a second 500ml beaker.
 - A scrubber fan is available for purchase to place scrubber media in. The fan container increases the volatiles scrubbing rate. Please see page 90.
2. Place the first media sample in the workspace chamber.
3. Swap out carbon media samples after every 24 hours in the workspace chamber.
4. Carbon media must be reactivated by baking. For best results, reactivate carbon media the same day it will be placed into the chamber.
 - Bake at 160°C for at least 2 hours.

Use carbon scrubber media for 6 months, then discard.



CONDENSATION AND THE DEW POINT

Relative humidity inside the BACTRON300 should never exceed 80% at 25°C. Exceeding this threshold can result in condensate forming on the incubator and workspace surfaces.

Condensate will appear whenever the humidity level in the chamber reaches the dew point. The dew point is the level of humidity at which the air cannot hold more water vapor. The warmer the air, the more water vapor it can hold.

As the level of humidity rises in a chamber, condensate will first appear on surfaces cooler than the air temperature. Near the dew point, condensate forms on any item or exposed surface that is even slightly cooler than the air. When the dew point is reached, condensate forms on nearly all exposed surfaces.

Mild condensate may be present in BACTRON300 units fully loaded or loaded to near capacity with breathable media plates, depending on ambient temperature and humidity. Cold air blowing on the exterior of the BACTRON300 may help cause condensation in the workspace chamber by chilling the acrylic glass panels or metal bulkheads.

Managing excessive condensation at humidity levels that overwhelm the BACTRON300 condensate controller depends on either lowering the humidity level in the chamber or increasing its air temperature.

Note: Rising or falling air pressure from the weather will adjust the dew point up and down in small increments. If the relative humidity in the BACTRON300 is already near the dew point, barometric fluctuations may push it across the dew point threshold.

If excessive condensate is forming in the BACTRON300 chamber, check the following:

- Is the BACTRON300 exposed to an external flow of cold air such as an air-conditioning vent or a door to a cooler hallway or adjacent room? Block or divert the air, or move the BACTRON300.
- Does the ambient humidity in the room exceed the stated BACTRON300 operating range of 80% relative humidity? If so, lower the room humidity.
- Do the number of media containers in the BACTRON300 exceed its rating? Reduce the number of sample containers.
- Remove or cap open containers of water or media. Drain the condensate controller catch vessel frequently. **Do not drain the manometer.**

DEIONIZED AND DISTILLED WATER

Do not use deionized water for cleaning or humidifying the BACTRON300!

While commonly available in laboratory environments, deionized water is an aggressive solvent that attacks most metal surfaces. The use of deionized water in a BACTRON300 voids the manufacturing defect warranty and may damage the unit. The manufacturer recommends the use of distilled water in the resistance range of 50K Ohm/cm to 1M Ohm/cm, or a conductivity range of 20.0 uS/cm to 1.0 uS/cm, for cleaning and humidifying applications.

PRESSURE UNIT CONVERSION CHART

	InHg	kPa	Kgf/cm²	bar	psi	mmHG	mmH₂O	inH₂O
1 inHg	1	3.3863	0.0345	0.3386	0.4911	25.400	345.32	13.6087
1 kPa	0.2953	1	0.0102	0.01	0.1450	7.5006	101.97	4.01463
1 Kgf/cm	28.9590	98.0665	1	0.9806	14.2233	735.55	10000.27	393.700
1 bar	29.5300	100	1.0197	1	14.5037	750.06	10197.44	401.463
1 psi	2.0360	6.8947	0.0703	0.0689	1	51.7150	703.09	27.7707
1 mmHG	0.0394	1.3332	0.0014	0.0013	0.0193	1	13.5954	0.53524
1 mmH₂O	0.0028	0.0098	0.0001	0.0001	0.0014	0.0029	1	0.03970
1 inH₂O	0.0734	0.2490	0.0025	0.0024	0.0361	1.86832	25.399	1

Figure 11: Pressure Measurement Unit Conversion

USER MAINTENANCE

Chamber Quality Control Check Sheet

Month:	Record Incubator Temperature	✓ Scrubber Changed	✓ Condensate Receptacle Drained	AMG Cylinder Pressure Reading	✓ Monitoring Strip Changed
Date:					
1					
2					
3					
4					
5					
6					
7					
8					
9					
10					
11					
12					
13					
14					
15					
16					
17					
18					
19					
20					
21					
22					
23					
24					
25					
26					
27					
28					
29					
30					
31					

You may copy this sheet for institutional use.

DAILY MAINTENANCE

1. Swap out the O₂ scrubber cartridge in the chamber with a reactivated scrubber.
2. Bake out the O₂ scrubber removed from the workspace chamber.
3. Empty the condensate collection container, as needed.
4. Change the anaerobic monitoring strip at least once every 24 hours or more often, as needed. The strip in the workspace chamber must remain moist in order to indicate the presence of oxygen.
5. Check that the airlock gaskets are properly seated.
6. Check the sleeve cuffs for holes, tears, and other signs of wear that may compromise integrity. Replace, if necessary.
7. Verify the incubator is set to the correct temperature.
8. Record the gas regulator supply reading.
 - Tracking gas usage prevents supply shortages and provides a record for tracking the emergence of any leaks in the gas system.
9. **Optional:** Swap out and reactivate volatile compounds scrubber media, if installed. Please see the **Volatile Compound Scrubber and Rejuvenation Cycle** on page 63 in the *Operations* section.
10. Check the water level in the manometer. While the chamber is operating under its normal overpressure of 0.5 inch, the water level should be even with the lower of the two reference rings (red).
11. Clean and disinfect the workspace chamber in accordance with your laboratory or production protocols, or regulatory requirements.

NORMAL GAS CONSUMPTION

A sealed and undisturbed BACTRON300 will typically go for more than 30 minutes between gas injections into the workspace chamber. The AMG Injecting light will illuminate while pulsing gas into the workspace chamber, accompanied by a pair of audible clicks from the gas solenoid opening and closing.

Airlock cycles, entering or exiting the armports, and working in the workspace chamber will temporarily increase the frequency of gas injections.

When the BACTRON300 is sitting sealed and undisturbed, AMG injections every twenty to thirty minutes **may** indicate a small leak. Injections every 10 – 30 seconds in an undisturbed BACTRON300 indicate a major leak.

TROUBLESHOOTING PERSISTENT OXYGEN IN THE CHAMBER

1. Ensure the armport doors are being correctly installed (page 30) and sleeve assemblies are correctly attached (page 50).
2. Verify proper sleeve donning and armport entry and exit procedures have been used. Page 52.
3. Check if samples and closed containers have been improperly introduced into the chamber. See page 63.
 - Samples and containers should not be introduced until the BACTRON300 has run with an anaerobic atmosphere in the chamber for at least 24 hours.
4. Verify the manometer is filled with 2 fl oz (60 ml) water. See page 28.
5. If the manometer water bottle was removed for filling, verify the bottle has been properly screwed back into the manometer body.
 - An improperly threaded bottle allows chamber atmosphere to leak directly through the manometer body, bypassing the pressure containment of the manometer water airlock.
6. Verify the AMG cylinder or in-house supply regulator is set to at least 50 psi to ensure adequate pressure is delivered to the BACTRON300.
 - Failure to properly attach supply lines to both ports will allow O₂ into the chamber when the airlock is cycled. Check for kinks or damage to the AMG supply line.

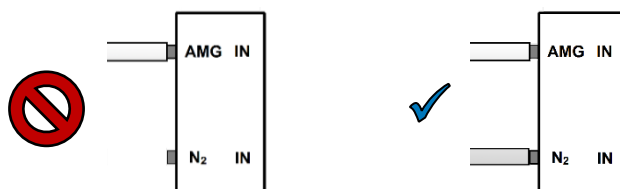

7. If used, verify the N₂ cylinder or in-house supply regulator is set to at least 50 psi to ensure adequate pressure is delivered to the BACTRON300.
8. Verify that the anaerobic monitoring strips are properly handled and not placed in an incubation chamber. The strips are heat sensitive and will register a false O₂ reading from heat discoloration. See page 55.
 - Make sure the monitoring strip packets have not been opened in an oxygenated atmosphere prior to being placed in the chamber.
9. Verify the O₂ scrubber cartridge is activated.
 - See the [Testing the O₂ Scrubber Cartridges](#) procedure on page 74.
10. Set the airlock cycle to 5 iterations to reduce post-cycle oxygen in the airlock chamber.
 - The airlock should not be used until the BACTRON300 has run with an anaerobic atmosphere in the workspace chamber for at least 24 hours, except as a diagnostic.

LEAK DIAGNOSTIC – UNIT IN USE PROCEDURE

Perform this procedure to check for leaks in and around the workspace chamber when the BACTRON300 is loaded with samples and cannot be taken out of use. Leaks can result from damage, long-term wear on BACTRON300 components, or user error.

Establish a Baseline

A baseline of AMG usage should be established before attempting to determine if the chamber is leaking. AMG usage increases when users access and work in the workspace chamber, therefore, the baseline should be established when the unit is sitting undisturbed.

1. Record the gas cylinder supply level at the end of the workday. Note the gauge level the next morning. Read the **Normal Gas Consumption** description on page 68.
2. If the BACTRON300 is using a significant amount of AMG overnight while sitting undisturbed, a gas leak is likely. Review the AMG cylinder readings recorded in the maintenance log to see if a period of increased usage or loss can be identified.
3. If the BACTRON300 is injecting AMG more frequently than every 30 minutes after sitting undisturbed overnight, there is likely a leak.
 - The normal injection rate of every 30 minutes or more sustains the chamber overpressure.

Verify Chamber Overpressure

Verify that the manometer has been periodically refilled or topped off as part of daily maintenance. If filled correctly, the water in the manometer should sit even with the bottom measuring ring of the manometer while the BACTRON300 is on and automatically maintaining overpressure in the chamber.

1. If the manometer is: **(a)** correctly filled, and **(b)** the water level is not depressed to the lower reference ring, and **(c)** the BACTRON300 is not injecting AMG frequently, the unit may be failing to inject gas as required to maintain the chamber overpressure.
2. If the manometer water level is not depressed and the BACTRON300 is injecting AMG frequently, it is likely there is a significant leak.

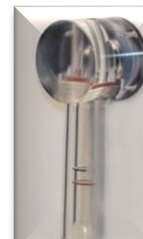

**0.5 inches
(1.27 cm) water
column pressure**

Check the Airlock

Verify the integrity of the airlock if the previous steps indicate a leak.

1. Check the airlock door gaskets. There should be no brittleness or dryness, and no cracks.
2. Check that both gaskets are securely seated on the mounting frames. Sample media is sticky, and if spilled, can cause an airlock door to pull a gasket off the mounting frame.
 - The airlock door windows should sit flush against the door gaskets when the doors are closed.
3. Confirm that users are closing the inner airlock door after transferring items into or out of the workspace chamber.

Check the Armport Doors

Failure to correctly close and latch the armports can result in the chamber leaking anaerobic atmosphere and increasing the rate of gas injections while sitting undisturbed.

1. Check the door ring-seals for signs of damage or excessive wear. Replace the rings if there are obvious signs of damage or wear.
2. Check that the armport doors are sealed and secure when not in use.
 - a. The locking bars should be in the horizontal position.
 - b. The knobs should be tightened clockwise **using only wrist strength**. Tightening the knobs too tight can damage the doors. This can result in a leak of chamber atmosphere around the threaded post on which the knob is mounted.
 - c. The door should sit snugly in the port when correctly sealed. **Use finger strength only** to check that the door does not rock in the port.

Locating Leaks

A gas leak detector capable of detecting hydrogen (Part Number 4600501) can be used to locate leaks along the sealed edges of the acrylic glass panels, armport doors, the outer airlock door, and back panel.

The manometer exhaust port on the back of the BACTRON300 will register as a leak under normal operating conditions. Some hydrogen gas naturally diffuses through the water-filled manometer. **Do not seal or otherwise obstruct the manometer exhaust port.** Doing so compromises the BACTRON300 overpressure and gas regulation system and voids the manufacturing defect warranty.

Fixing a Leak

Contact your institutional maintenance department or Technical Support for assistance if a leak is confirmed, or if increased gas usage is not restricted to periods when users are working in the BACTRON300.

Excessive AMG Usage During Work Hours

Check the following items if AMG usage is excessive when users are working in the BACTRON300.

- Verify users are operating the airlock correctly.
- Confirm that users are employing correct sleeve donning, entry, and exit procedures.
- Confirm the integrity of the sleeves and sleeve components.
- Read the [AMG Conservation Methods](#) entry on page 75 for ways to reduce AMG usage.

LEAK CHECK – UNIT EMPTY

Use this comprehensive procedure to check the atmospheric integrity of the workspace chamber when the BACTRON300 can be taken out of operation. All samples should be removed from the chamber prior to carrying out this procedure since aerobic atmosphere will be present in the chamber.

This procedure places the unit at a steady-state temperature and atmospheric pressure before performing a set of leak checks.

1. Turn off the BACTRON300.
2. Remove the left armport sleeve and open the left armport door.
3. Remove the O₂ scrubber cartridge from the BACTRON300 to prevent its presence from interfering with the leak check.
 - The catalytic production of water vapor reduces the volume and pressure of the chamber atmosphere. This can interfere with a leak check.
4. Verify the manometer is filled with water up to the top reference ring (the fill line).
5. Check the integrity of the airlock door gaskets.
6. Replace the gasket if brittleness, dryness, or cracks are present.
7. Clean the gaskets with warm water and soap if sticky or dirty. Dry and seat securely on the airlock mounting frames.
8. Close and latch both airlock doors.
9. Verify that the window panel of each airlock door sits flush against the door gasket.
10. Check the armport door ring seals for signs of damage or wear.
11. Close and secure the left armport.
12. Check that both the armport doors are correctly latched, with the locking bars in the horizontal position, and the knobs snugly tightened clockwise using wrist strength.
13. Check that the AMG gas regulator is set to 50 psi.
14. Open the gas cylinder valve all the way On if not already opened.
15. Turn on the BACTRON300.
 - a. The AMG Injecting light should illuminate.
 - b. The manometer water level should be forced down to the bottom of the two measuring rings (the red line).

16. Set the incubator(s) to Off to prevent heating.
 - An incubator actively heating from room temperature to achieve a setpoint increases air pressure in the chamber due to thermal expansion of the chamber atmosphere. This can interfere with performing an accurate leak check.
17. Monitor the BACTRON300 for 40 minutes. After the first 10 minutes, the unit should only inject once every 30 minutes.
 - If there is a leak, the AMG Injecting light will illuminate more frequently than every 30 minutes.
 - AMG chamber injections every 10 – 20 minutes are indicative of a large leak.
 - Failure to obtain 0.5 inches of chamber overpressure as indicated by the manometer is indicative of a leak. Check to see if the chamber atmospheric pressure switch that sets the overpressure level needs to be adjusted. Adjusting the chamber pressure switch is a service-level procedure.

Locating Leaks

See the [Locating Leaks Entry](#) (page 69) for instructions on using a hydrogen leak detector to pinpoint or find the leak. The hydrogen detector only finds leaks if AMG is present in the chamber.

DOOR GASKET MAINTENANCE AND USAGE

BACTRON300 door gaskets are subject to significant compression during airlock cycles. Users cycling the airlock more than 15 times per day will need to replace the door gaskets every 3 to 6 months. Heavy institutional users may wish to keep a pair of spare door gaskets on hand. Please see the parts list on page 88.

Cleaning: Spilling sample media on door gaskets or the interior surfaces of airlock doors may cause the gaskets to stick to the doors. This can compromise the atmospheric integrity of the airlock. Gaskets can be cleaned with dish soap and warm water if permitted by your laboratory or production protocol.

SLEEVE MAINTENANCE AND USAGE

Sleeves may be washed with dish soap and warm water between uses. Disinfection should be carried out per laboratory or production protocols. Institutions with several users for each BACTRON300 may wish to keep a pair of sleeves in small, medium, and large sizes on hand, or keep a pair of sleeves for each user.



CAUTION: The catalytic scrubber grows hot in the presence of free oxygen and AMG. **DO NOT** touch the scrubber cartridge body, and use caution when touching the scrubber cartridge handle.

O₂ SCRUBBER CARTRIDGE: TEST IN THE CHAMBER

A test to see if a scrubber cartridge inside the workspace chambers is still active.

2. Place the scrubber in the anaerobic airlock.
 - If the airlock is not anaerobic, run a cycle before opening the inner airlock door.
2. Position the scrubber so the cartridge does not touch either airlock door.

Figure 12: Placement of scrubber cartridge in the Airlock

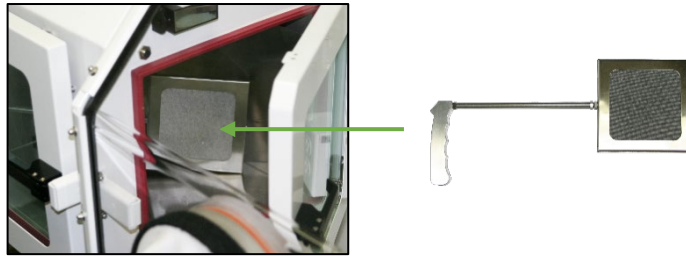

3. Close the inner airlock door.
4. Open the outer airlock door to allow aerobic atmosphere into the airlock chamber.
5. Close the outer airlock door.
6. **Cycle the airlock** with the scrubber cartridge inside. See page 60.
7. After the cycle is complete, open the inner door and place your hand **near** the scrubber cartridge to check for heat. **Do not touch the cartridge!**
 - An activated scrubber will have grown warm in the presence of oxygen and AMG during an airlock cycle.
8. If the scrubber is cool or only slightly warm, reactivate by baking for a minimum of 8 hours. Please see the **Reactivating Scrubber Cartridges** procedure below.



**Auto
Cycle**

REACTIVATING O₂ SCRUBBER CARTRIDGES

Reactivate each cartridge after 24-hours of use in the workspace chamber. Failure to do so leaves the scrubber cartridge unable to remove free oxygen from the workspace chamber atmosphere.

1. Bake the catalyst cartridge at 200°C for a minimum of 8 hours.
2. Remove the cartridge handle before heating and reinstall the handle after baking.
3. Use appropriate Personal Protective Equipment (PPE) to prevent burns.
4. Reactivating helps remove buildups of volatiles that would otherwise prevent free oxygen and AMG hydrogen from impacting the palladium surfaces of the scrubber cartridge.

QUALITY CONTROL TEST – SCRUBBER CARTRIDGES

Perform a quality control test on each O₂ Scrubber cartridge once per month.

1. Place a reactivated O₂ scrubber cartridge in the airlock with an aerobic atmosphere and run the auto cycle.
 - The palladium-coated pellets inside the catalyst cartridge should grow warm in the presence of oxygen and hydrogen indicating that the cartridge is ready for use.
2. If the cartridge is not hot after the cycle, bake the cartridge at 200°C for at least 8 hours.
3. **Cleaning** - While the scrubber is still hot from the oven, flow AMG over the cartridge in the aerobic air of the room. Utilize appropriate PPE.

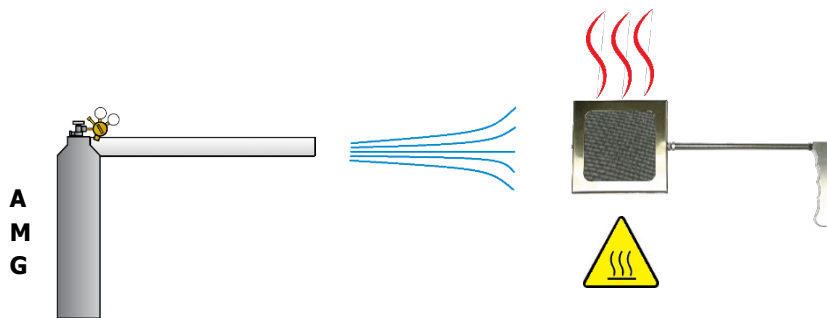

- This helps remove buildups of hydrogen sulfides and other contaminants that interfere with cartridge effectiveness.
4. Allow the cartridge to cool after flowing AMG over it.
 5. Retest by placing the cartridge in the BACTRON300 airlock with an aerobic atmosphere and cycling the airlock.

AMG CONSERVATION METHODS

- Minimize the number of airlock cycles per day.
- Use the dual AMG - N₂ gas configuration for auto cycling the airlock.
- Move a large number of items through the airlock in one transport to reduce the volume of AMG used cycling the airlock. A greater volume of solids reduces the gas backfill volume.
- When transporting a small number of items, place a large solid object in the airlock. This reduces the volume of gas utilized.
- Introduce small individual items, such as sealed microplates or transport tubes, into the workspace chamber through the sleeve assemblies rather than the airlock.
- Employ proper sleeve techniques when entering and exiting the workspace chamber.
- Avoid fast or large movements while working in the chamber. Use a swimming motion, withdrawing one arm partly from the armport while reaching in with the other arm.

Figure 13: Reassembling the Sleeve Assembly

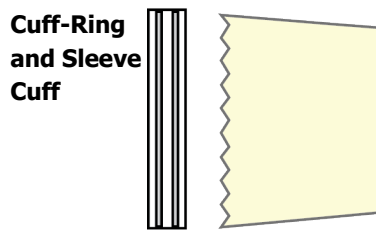

REPLACING SLEEVE COMPONENTS

Replacing the sleeve components requires performing the following steps to disassemble the sleeve assembly:

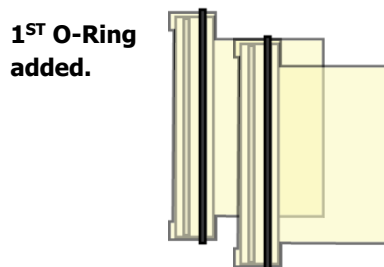
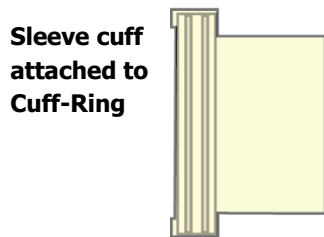

1. Roll the black O-ring off the cuff on the outside of the sleeve assembly.
2. Pull the sleeve cuff and cuff-ring out of the sleeve body.
3. Remove the 2nd black O-ring.
4. Remove the sleeve cuff from the cuff-ring.
5. Inspect all components for brittleness, dryness, holes, or cracks. Replace as needed.
 - The cuffs have the fastest rate of wear.

Reassemble the sleeve assembly:

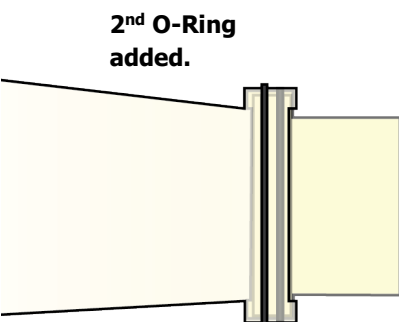
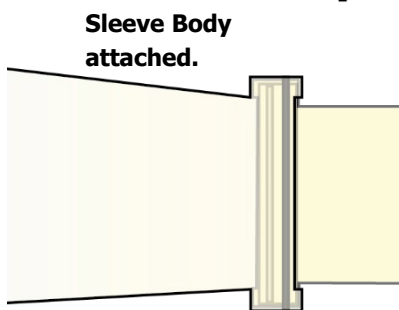

1. Pull the wide, fringed side of the sleeve cuff on over the cuff-ring.
2. Roll an O-ring onto the cuff-ring and over the sleeve cuff. Place the ring into the groove opposite the fringed side of the cuff.
3. Pull the narrow end of the sleeve body over the sleeve cuff and cuff-ring. The fringed end of the sleeve cuff should be inside the sleeve body, and the body of the cuff should protrude from the sleeve.
4. Roll on the second O-ring. Place the O-ring into the unoccupied cuff-ring groove.

End of Procedure

Warning: Prior to any maintenance or cleaning of this unit, disconnect the power cord from the power supply.

Avertissement: Avant tout entretien ou nettoyage de cet appareil, débranchez le cordon d'alimentation de l'alimentation.



CLEANING AND DISINFECTING

If a **hazardous material or substance** has spilled in the unit, immediately initiate your site Hazardous Material Spill Containment protocol. Contact your local Site Safety Officer and follow instructions per the site policy and procedures.

1. The BACTRON300 should be cleaned and disinfected prior to first use.
2. Periodic cleaning and disinfection are required to prevent microbiological contamination.
3. **Do not** use spray-on cleaners or disinfectants. These can leak through openings and coat electrical components.
4. **Do not** use cleaners or disinfectants that contain solvents capable of harming paint coatings, acrylic glass, or stainless steel surfaces. **Do not use chlorine-based bleaches or abrasives—these will damage the chamber liner.**
5. Consult the manufacturer or their agent if you have any doubts about the compatibility of decontamination or cleaning agents with any part of the equipment or material contained.

Warning: Never clean the unit with alcohol or flammable cleaners.

Avertissement: Ne jamais nettoyer l'appareil avec de l'alcool ou des nettoyeurs inflammables



Cleaning

Keep the following in mind when cleaning the BACTRON300 interior.

- Remove and clean the sleeve assemblies and all removable workspace chamber accessory items, except the currently installed O₂ scrubber cartridge.
 - **Do not clean the catalytic O₂ scrubbers using water, cleaning agents, or disinfectants!** Clean the scrubber cartridge using heat and AMG (see page 73).
- Wash the armport doors, sample dish racks, shelf spacers, airlock gaskets, and sleeve assemblies with a mild soap and water solution.
- Clean the workspace chamber, incubator, and airlock interiors with a mild soap and water solution, including all corners.
 - Take special care when cleaning around and chamber power outlets to prevent damage. Do not clean the airlock door alarm sensors.
 - Do not use chloride-based cleaners, except Zephiran benzalkonium chloride solution. Other types may have adverse effects on microbiological samples.
- Rinse with distilled water and wipe dry with a soft cloth. Do not use deionized water. Please see page 65 for more information on DI water.
- Wipe down the interior surfaces with Zephiran. Allow the Zephiran to evaporate, do not wipe it up.

Disinfecting

Keep the following points in mind when carrying out your laboratory, clinical, or production space disinfection protocol:

- **Turn off the BACTRON300 to safeguard against electrical shocks.**
- Disinfect the BACTRON300 using commercially available disinfectants that are non-corrosive, non-abrasive, and suitable for use on stainless steel, painted surfaces, and acrylic glass. Contact your local Site Safety Officer for detailed information on the disinfectants compatible with your cultivation or culturing applications.
- Do not use overtly volatile disinfecting agents. Chlorines, amphylys, and quaternary ammonias will evaporate into the chamber environment. Concentration in the chamber atmosphere will increase over time, potentially leading to inhibited growth or metabolic symptoms in sample populations.
- Open all the BACTRON300 doors to facilitate disinfection, ventilation of disinfectants, and drying.
- If possible, remove all interior accessories (shelf spacers, Petri dish racks, and other non-attached items) from the chamber when disinfecting.
- Disinfect all corners of the workspace chamber, the incubator interior(s), and the airlock interior.
- Take special care not to damage the armport door gaskets or the airlock door gaskets.
- The manometer glass water bottle can be autoclaved.
- After completion of your institutional protocol, allow all disinfectants to evaporate completely. Wipe down all surfaces except the door sensors with distilled water and Zephiran until the BACTRON300 no longer has a volatile odor. Use nonabrasive wipes.



**Shock or
Fire Hazard**



Figure 14: Airlock Door Sensor

MAINTAINING THE ACRYLIC GLASS PANELS

Cleaning and Scratches

The manufacturer recommends using Novus brand acrylic glass cleaner and scratch remover for cleaning and maintaining acrylic glass surfaces on the BACTRON300. Please see the [Accessories section](#) on page 90. Alcohol or alcohol-based solvents and other aggressive solvents should never be used to clean the BACTRON300 and may damage the acrylic glass panels.

Ultraviolet Lighting

Never expose the BACTRON300 to sustained UV light. Prolonged exposure to UV will result in rapid aging of the acrylic glass, leaving it vulnerable to compression forces, and generating cracks across all exposed areas. UV light will also quickly age sleeve assemblies, turning the sleeves yellow and result in a rapid loss of elasticity.

The BACTRON300 should not be exposed to direct sunlight.

Damage from exposure to UV light is not covered under the manufacturing defect warranty.

Disable or redirect laboratory disinfection UV lighting away from the BACTRON300. Verify that your laboratory or workspace environment does not use UV disinfection lighting at night. This type of light is usually referred to as short-wave UVC or germicidal UV light and operates at roughly 254 nm.

Periodic use of long-wave (365 nm) UV hand lamps used for bacterial identification should not damage the acrylic glass.

ELECTRICAL COMPONENTS

Electrical components do not require maintenance. If the electrical systems fail to operate as specified, please contact your BACTRON300 distributor or technical support for assistance.

CALIBRATE THE TEMPERATURE DISPLAY

Note: Performing a temperature display calibration requires a temperature reference device. Please see the [Temperature Reference Device entry](#) on page 12 for the device requirements.



Temperature Reference Device

Temperature calibrations are performed to match an incubator temperature display to the actual air temperature inside the incubator which is supplied by a calibrated reference device.

Calibrate as often as required by your laboratory or production protocol, or regulatory compliance schedule. Always calibrate to the industry standards and use the calibration setup required by your laboratory protocol.

BACTRON300: Each temperature display must be separately calibrated to its incubator.

Suggested Calibration Setup



1. Use the airlock to introduce the **Temperature Reference Device** into the workspace chamber. Cycle the airlock.
2. Introduce the sensor probes into the incubator through an open incubator door.



Painters tape or other non-stick tape recommended

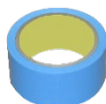

3. Position the sensor head at least 2 inches (50 mm) from the shelf surface and as near as possible to the geometric center of the chamber. This ensures the air temperature is being measured. Secure the thermocouple probe to the shelving with non-marking tape.
4. Close the incubator doors. Seal any gaps along the side of the doors using painter's tape or any other non-stick tape. **Do not seal the finger holes on the workspace incubator door!**

Temperature Stabilization

The incubator air temperature must stabilize in order to perform an accurate calibration.

1. Allow the incubator to operate undisturbed with the doors shut for **at least 24-hours** when first putting the BACTRON300 into operation in a new environment.
2. Operating **8-hours** undisturbed with the doors shut will suffice for a BACTRON300 that has been in operation for at least 1 day.
3. To be considered stabilized, the incubator chamber must operate at your calibration temperature for **at least 1 hour with no fluctuations of $\pm 0.2^{\circ}\text{C}$ or greater.**

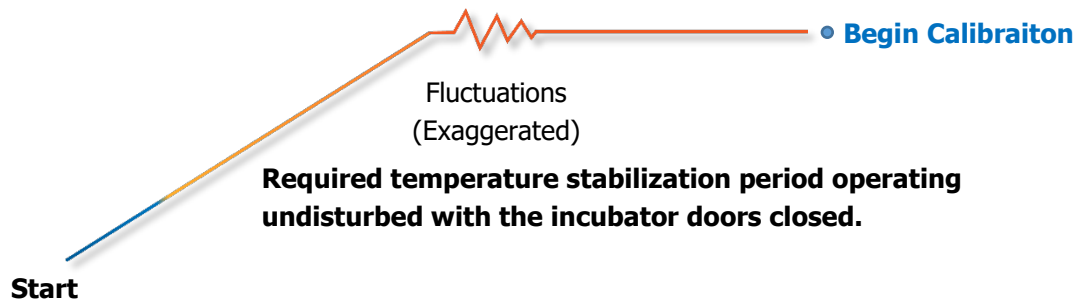

Suggested Temperature Calibration

- 1 When the incubator temperature has stabilized, compare the reference device and incubator temperature display readings.
 - If the readings are the same, or the difference between the two readings falls within the acceptable range of your protocol, the display is accurately showing the incubator air temperature. **The Temperature Calibration procedure is now complete.**
 - Or -
 - If a difference falls outside of your protocol range, advance to step 2.



- 2 A display calibration adjustment must be entered to match the display to the reference device. See next step.



Temperature Calibration (continued)

3 Place the display in its temperature calibration mode.

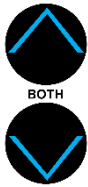

- a. Press and hold both the **UP and DOWN** temperature arrow buttons simultaneously for approximately 5 seconds.
- b. Release the buttons when the temperature display shows the letters "C O". The display will begin flashing the **current temperature display value**.



Note: If an arrow key is not pressed for five seconds, the display will stop flashing and store the last displayed number as the new current chamber temperature value.

4

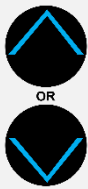

Use the **Up** or **Down** arrows to adjust the current display temperature value until it matches the reference device temperature reading.

Reference Device

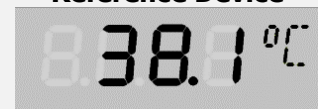

5

After matching the display to the reference device, wait 5 seconds.



Wait 5 Seconds

- The temperature display will stop flashing and store the corrected chamber display value.
- The incubator will now begin heating or passively cooling in order to reach the setpoint with the corrected display value.



Cooling to SetPoint

6



Wait 1 Hour

After the incubator has achieved the corrected temperature, allow the BACTRON300 to sit at least one (1) hour undisturbed to stabilize.

- Failure to wait until the incubator is fully stabilized will result in an inaccurate reading.



SetPoint Achieved

Temperature Calibration (continued)

- 7** Compare the reference device reading with the chamber temperature display again.

- If the reference device and the chamber temperature display readings are the same or the difference falls within the range of your protocol, **the incubator is now calibrated for temperature.**

- OR -

- See the next step if the readings fail to match or fall outside of your protocol range.

Reference Device



- 8** If the two readings are not the same, and the difference still falls outside the acceptable range of your protocol, repeat steps 3 – 7 up to two more times.

Three calibration attempts may be required to successfully calibrate units that are more than $\pm 2^{\circ}\text{C}$ out of calibration.

Reference Device



- 9** If the temperature readings of the incubator temperature display and the reference device still fall outside your protocol after three calibration attempts, contact your BACTRON300 distributor or **Technical Support** for assistance.

End of procedure

This page left blank.

UNIT SPECIFICATIONS

These BACTRON300s are either 110 – 120 volt units or 220 – 240 volt units. Please refer to the unit data plate for individual electrical specifications.

Technical data specified applies to units with standard equipment at an ambient temperature of 25°C (77°F) and nominal voltage. The temperatures specified are determined in accordance with factory standard following DIN 12880 respecting the recommended wall clearances of 10% of the height, width, and depth of the inner chamber. All indications are average values, typical for units produced in the series. We reserve the right to alter technical specifications at any time.

POWER

Model	AC Voltage	Amperage	Frequency
BACTRON300	110 – 120	11.0	50/60 Hz
BACTRON300-2	220 – 240	8.0	50/60 Hz

UNIT WEIGHT

Model	Unit Weight
BACTRON300	304 lb / 138 kg

SHIPPING WEIGHT

Model	Shipping Weight
BACTRON300	526 lb / 239 kg

UNIT DIMENSIONS

Inches

Model	Exterior W × D × H	Workspace Chamber W × D × H
BACTRON300	61.8 x 32.0 x 27.6 in	42.5 x 28.9 x 25.0 in

Millimeters

Model	Exterior W × D × H	Workspace Chamber W × D × H
BACTRON300	1570 x 813 x 701 mm	1059 x 734 x 635 mm

UNIT SPECIFICATIONS

SHELF DIMENSIONS

Model	Inches W × D	Millimeters W × D
BACTRON300	27.3 × 7.4	694 × 188

AIRLOCK DIMENSIONS

Interior

Model	Inches W × D × H	Millimeters W × D × H
BACTRON300	16.0 × 10.0 × 11.5	406.4 × 254 × 292

INCUBATOR DIMENSIONS

Workspace Chamber Incubator

Model	Inches W × D × H	Millimeters W × D × H
BACTRON300	27.5 × 8.5 × 13.5	699 × 216 × 343

VOLUMES AND CAPACITY

Workspace Chamber Volume

Model	Cubic Feet	Liters
BACTRON300	16.0	453.0

Plate Capacity

Model	Plates
BACTRON300	300

Airlock Plate Capacity

Model	Plates
BACTRON300	216

UNIT SPECIFICATIONS

TEMPERATURE

Operating Temperature Range

Model	Range
BACTRON300	Ambient +5°C to 70°C

Temperature Uniformity

Model	Workspace Incubator
BACTRON300	±1.0°C @ 37°C

Temperature Stability

Model	Workspace Incubator
BACTRON300	±0.2°C @ 37°C















POWER

Model	AC Voltage	Amperage	Frequency
BACTRON300	110 – 120	11.0	50/60 Hz
BACTRON300-2	220 – 240	8.0	50/60 Hz

OXYGEN

When sitting undisturbed in a steady state, a BACTRON300 typically rests at lower than **4.7 parts per million oxygen** in the workspace chamber.

PARTS LIST

Description	Parts Number	Description	Parts Number
Anaerobic Monitoring Strips (Box of 100 packets)	 9900706	Power Cords (2), 5-15P NEMA, 7.5 feet (2.29m), detachable	 1800510
Airlock Door Gasket, 1 Each 12in x 12in (burgundy)	 3450507	Foot Pedal Control	 9830516
Airlock Door Gasket, 1 Each 9 x 9 (burgundy)	 3450506	Fuse, Power Cord Inlet, Type T 12.5 Amp, 250V, 5x20mm	 3300520
Armport Door Left	 9900699	Fuses, Vacuum Pump, Type T 10Amp, 250V, 5x20mm	 3300516
Armport Door Right	 9900698	Fuse, Secondary Inlet for Interior Outlet: Type T 16.0 Amp, 250V, 5x20mm	 3300513
Armport Door O-Ring	 6000509	Gas Tubing white, 3/16ID, 5/16OD, 1 foot in length. Order by feet for an unbroken length.	 8500527
Armport Door Stand	 9990761	Petri Dish Rack, 2 stacks of 11 Petri plates (for workspace incubators)	 5110729
O₂ Scrubber Holder Assembly (includes catalyst cartridge. The unit requires 2 scrubbers for continual operation.)	 9990759		

PARTS

Description	Parts Number	Description	Parts Number
Leveling Foot	 2700506	Sleeve Cuffs Latex, Size 7 (for Small sleeve assembly)	 3600500
Sleeve Assembly Size 6, Extra Small (2 cuffs, 2 cuff-rings, 4 O-rings, 2 sleeve bodies, 2 self-gripping straps)	 9990812XS	Sleeve Cuffs Latex, Size 8 (for Medium sleeve assembly)	 3600501
Sleeve Assembly Size 7, Small (2 cuffs, 2 cuff-rings, 4 O-rings, 2 sleeve bodies, 2 self-gripping straps)	 9990738S	Sleeve Cuffs Latex, Size 9 (for Large sleeve assembly)	 3600502
Sleeve Assembly Size 8, Medium (2 cuffs, 2 cuff-rings, 4 O-rings, 2 sleeve bodies, 2 self-gripping straps)	 9990738M	Sleeve Cuffs Nitrile, Size 6 (for Extra Small sleeve assembly)	 9990777
Sleeve Assembly Size 9, Large (2 cuffs, 2 cuff-rings, 4 O-rings, 2 sleeve bodies, 2 self-gripping straps)	 9990738L	Sleeve Cuffs Nitrile, Size 7 (for Small sleeve assembly)	 3600525
Sleeve Cuff-Ring 4 Inches, interior diameter (for Small, Medium, and Large)	 6400590	Sleeve Cuffs Nitrile, Size 8 (for Medium sleeve assembly)	 3600526
Sleeve Cuff O-Ring, Black, 4 Inches (For the 4-inch Sleeve Cuff Ring. Two O-rings are required).	 6000504	Sleeve Cuffs Nitrile, Size 9 (for Large sleeve assembly)	 3600527
Sleeve Cuff-Ring 3.5 Inches, interior diameter (for extra-small sleeve assembly)	 6400619	Sleeve, Extra Small (10in to 3.5in dia.) (for XS sleeve assembly)	 9990775
Sleeve Cuff O-Ring, 3.5 inches, (For extra-small sleeve assembly. Only one is required.)	 6000503	Sleeve, Standard (10in to 4.0in dia.) (for S, M, L sleeve assemblies)	 3600521

ORDERING PARTS AND CONSUMABLES

Accessories and replacement parts can be ordered online at parts.sheldonmfg.com.

If the required item is not listed online or if you require assistance in determining which part or accessory you need, contact the BACTRON300 manufacturer by emailing parts@sheldonmfg.com or by calling 1-800-322-4897 ext. 4 or (503) 640-3000 ext. 4.

Please have the **model**, **serial**, and **part** numbers, and **Part ID** of the BACTRON300 unit ready. Tech Support needs this information to match your unit to its correct part.

ACCESSORIES

Activated Carbon Media (2 lbs / 0.9 kgs)

For scrubbing hydrogen sulfides, fatty acids, and some toxic or corrosive compounds from the chamber atmosphere.

Part Number 1060500



Activated Carbon, Volatile Compounds Scrubber Fan

Holds activated carbon scrubber media. Speeds the removal of sulfides, fatty acids, and toxic or corrosive compounds. For 110 – 120 volt units.

Part Number 9490578



Acrylic Glass Cleaner (2 oz. / 59.2 ml)

Novus brand acrylic glass cleaner.

Part Number 1060503



Acrylic Glass Scratch Remover (2 oz. / 59.2 ml)

Helps remove visible scratches and nicks from acrylic glass.

Part Number 1060504





AMG Regulator

Required, but not included. Must be ordered separately either from Sheldon Manufacturing or from the vendor of your choice.

Part Number: 7150514



Anaerobic Indicator Strips

1 box of 100 Oxoid brand oxygen-detecting anaerobic indicator strips.

Part Number 9900706

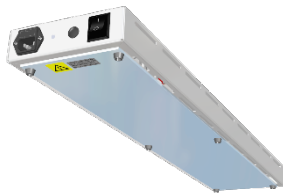

BACTRON300 LED Light Unit 220V

A BACTRON300 LED lamp that sits on top of the workspace chamber. 220V.

Part Number: 9730520



BACTRON300 Rolling Stand

A rolling stand with cabinet.
29.3 inches high by 61.5 inches wide
(74cm high by 156cm wide)

Part Number: BACSTAND-MD22



Gas Leak Detector

A handheld gas detector for locating AMG leaks. Recommended for units that have been in service for 4 or more years.

Part Number 4600501

Leica S6 Spotting Stereo Microscope and Assembly

Requires the appropriate microscope adaptor.

Part Number 9990516



Lukas Fiber Optic Micro Lite Illumination System

A fiber optic, adjustable brightness, halogen light box and guide. Provides a stable, long-lasting light for use with chambers and stereo microscopes.

Part Number 4650503



Nitrogen Regulator Kit

Delivery gauge range of 2 – 60 PSIG. Includes barbed adaptor fitting and 16 feet (4.9 meters) of flexible tubing.

Part Number 9740567



UV Viewing Lamp

A handheld UV viewing lamp.

Part Number 9490507



Zephiran Benzalkonium Chloride Chamber Cleaner

1 Gallon, 0.133%.

Part Number 1060501



This page left blank.

AMG USAGE

1. **All values are approximate** and affected by ambient temperatures.
2. All values are for automated cycles using the factory default settings.
3. Gas usage during manual cycles is dependent on the unit operator.

Automated Commissioning Cycles

Model	Standard Cubic Feet	Standard Liters
BACTRON300	16.00 scf	453 sl
BACTRON300-2	16.00 scf	453 sl

Displayed supply gauge pressure: The BACTRON300 uses approximately 400 psi of gauge pressure from a size 300 cu.ft. gas cylinder.

Airlock Auto Cycles

These usage figures are for BACTRON300s using a **supplementary nitrogen supply** (the dual gas configuration), so that AMG is only used during the final backfill of the airlock. Without the nitrogen supply, a 3-phase cycle uses approximately three times as much AMG. A 4-phase cycle consumes around four times as much, etc.

Model	Standard Cubic Feet	Standard Liters
BACTRON300	1.2 scf	33 sl

Sleeve Auto Cycles

Model	Standard Cubic Feet	Standard Liters
BACTRON300	0.8 scf	22 sl

Resting State

When a BACTRON300 is sitting sealed and undisturbed, it uses **approximately 4 – 15 standard liters per day** (0.15 – 0.53 scf per day).

PLC INPUTS AND OUTPUTS

The BACTRON300's Programmable Logic Controller (PLC) receives inputs from sensors and other components, triggering logic routines. These, in turn, generate outputs to power or depower the BACTRON300 components. These lamps are useful diagnostic indicators.

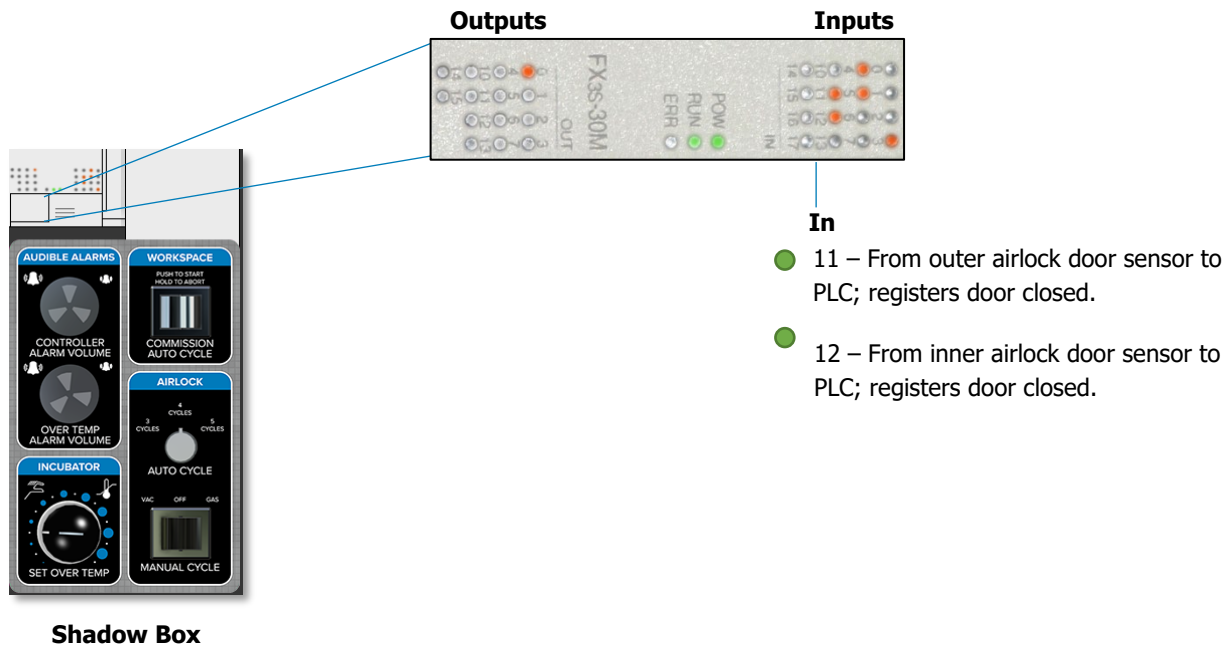





P.O. Box 627
Cornelius, Oregon, 97113
USA

support@sheldonmfg.com
sheldonmanufacturing.com

800-322-4897
503-640-3000